

Grade 1

44 Flip Books

Name _____

What do you
think is in the

Glue/Staple



mug?

By Lavinia Pop © 2015

Name: _____

think

Trace the following word:
think think think think think

4 of my Flip Book sentences are:
1. _____



bag?

Glue/Staple



box?

Glue/Staple



chest?

Glue/Staple



basket?

Name _____



What do you
think is in the

Glue/Staple

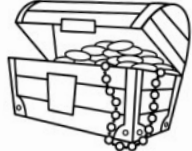

mug?

By Lavinia Pop © 2015

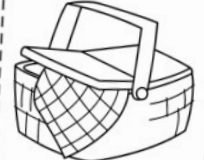
 <p>bag?</p>	 <p>chest?</p>	 <p>box?</p>	 <p>basket?</p>
---	---	---	--

Introduction

About this book:

This book contains a collection of 44 Grade 1 sight word flip books in black and white, as well as colour. Each flip book is followed by a writing worksheet for children to further practice the focus word.

Directions for use:

To assemble the flip books, cut out each rectangle, then along the lines of the bottom rectangle. Make sure that the top rectangle is left intact as it will form the base for the flip book! Arrange the “flips” (pages) one on top of the other and staple them to the base. Students will have lots of fun reading their flip books over and over again to friends and family!

Once children have finished reading their flip book, they then complete the writing sheet attached to each flip book.

Happy Teaching :)



Top and bottom rectangles have been cut out. TOP rectangle has been left intact.

“Flips” (pages) have been placed one on top of the other and stapled to the base.



Words Included

1. after
2. again
3. an
4. any
5. as
6. ask
7. buy
8. could
9. every
10. fly
11. from
12. give
13. going
14. had
15. has
16. her
17. him
18. his
19. how
20. just
21. know
22. let
23. live
24. made
25. may
26. of
27. old
28. once
29. open
30. over
31. put
32. round
33. some
34. stop
35. take
36. thank
37. them
38. then
39. think
40. us
41. walk
42. were
43. when
44. your

Glue/Staple

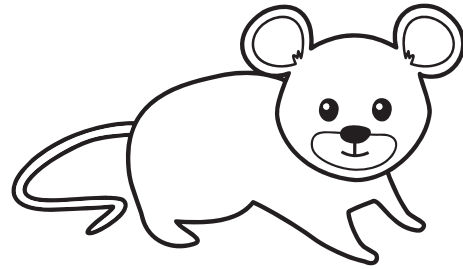

mouse

Name _____

ran after us.

By Lavinia Pop © 2015

The

Glue/Staple

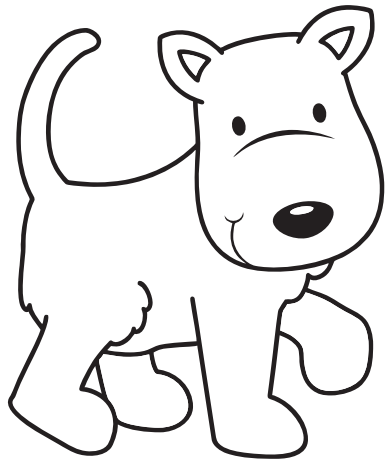

dog

Glue/Staple

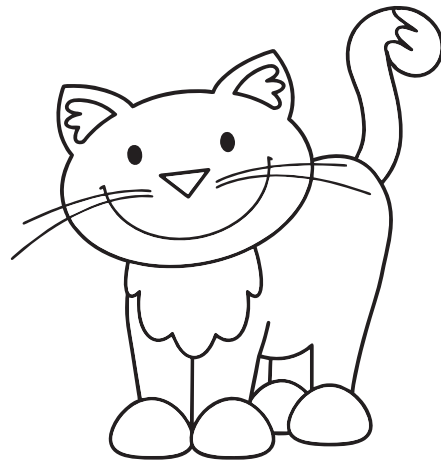

cat

Glue/Staple

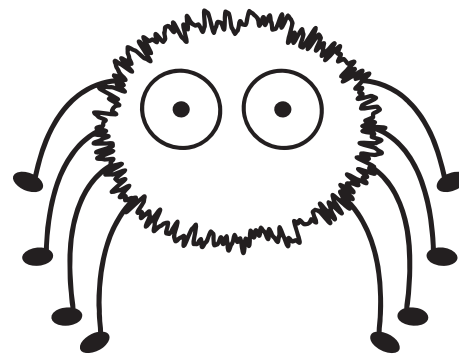

spider

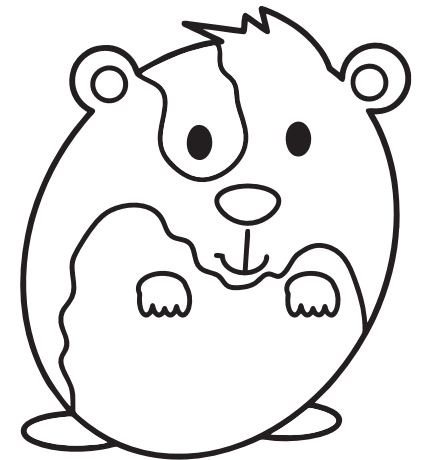

hamster

Name:

after



Trace the following word:

after after after after after



4 of my Flip Book sentences are:

1.

2.

3.

4.

Is it

Glue/Staple

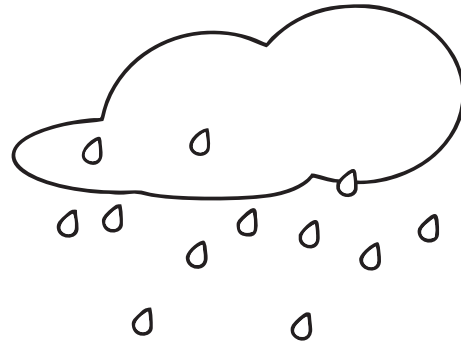

rainy

Name _____

again?

By Lavinia Pop © 2015



stormy

Glue/Staple

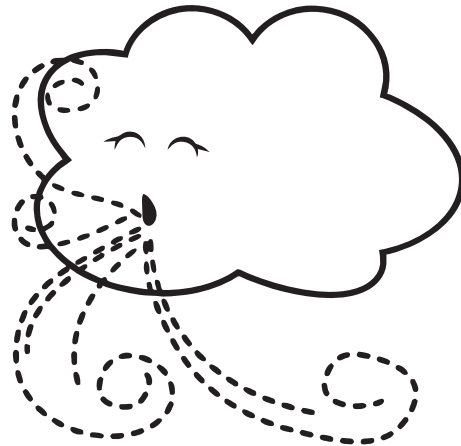

windy

Glue/Staple

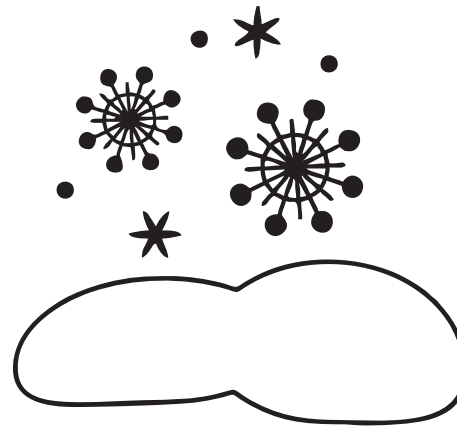

snowy

Glue/Staple

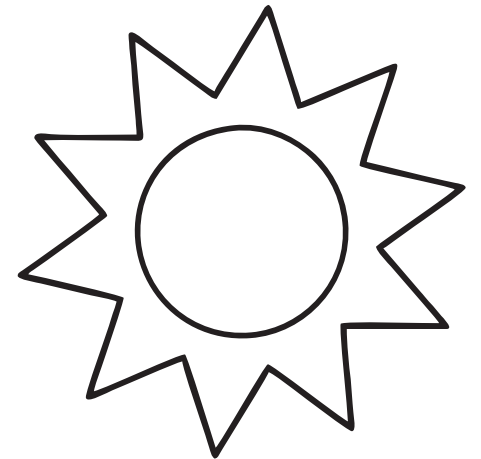

sunny

Name:

again



Trace the following word:

again again again again again



4 of my Flip Book sentences are:

1.

2.

3.

4.

Name _____

I see an

Glue/Staple

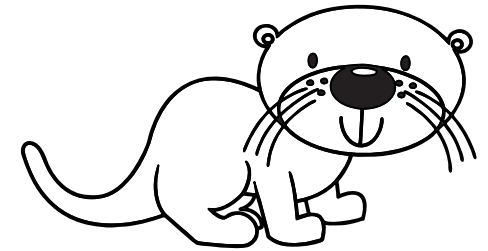

otter.

By Lavinia Pop © 2015

Glue/Staple

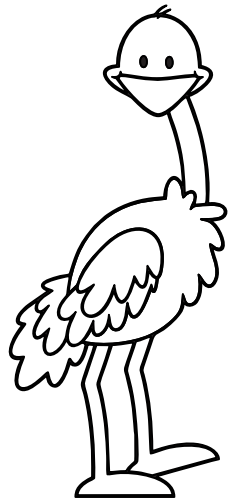

ostrich.

Glue/Staple

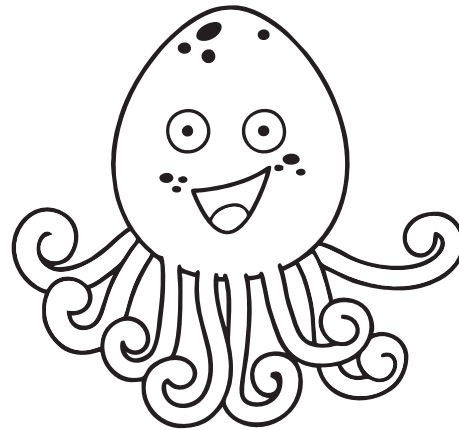

octopus.

Glue/Staple

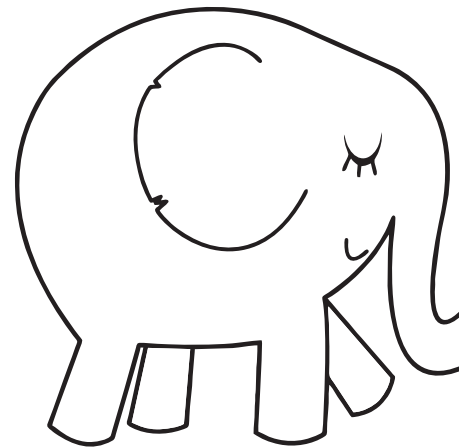

elephant.

Glue/Staple

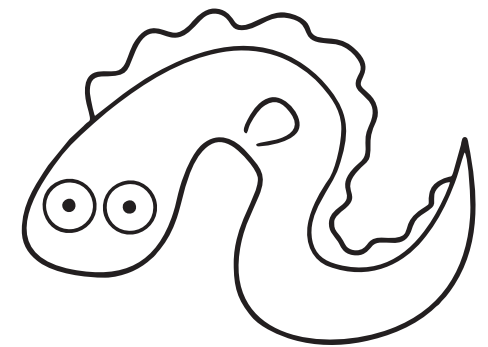

eel.

Name:

an



Trace the following word:

an an an an an



4 of my Flip Book sentences are:

1.

2.

3.

4.

Name _____

Glue/Staple

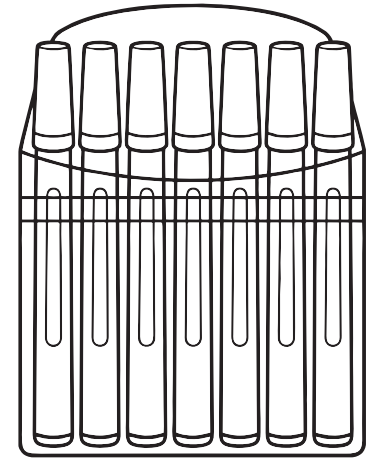

markers?

Do you have any

By Lavinia Pop © 2015

Glue/Staple

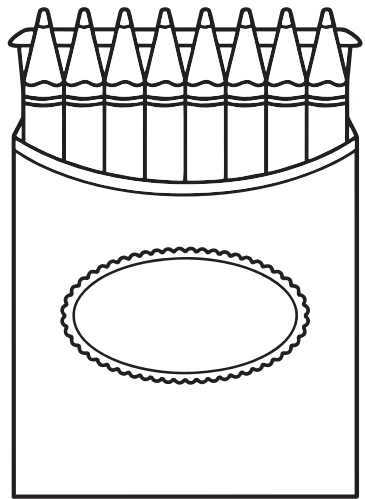

pencils?

Glue/Staple



glue?

Glue/Staple

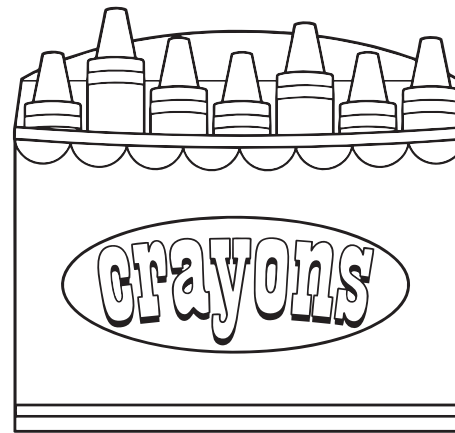

crayons?

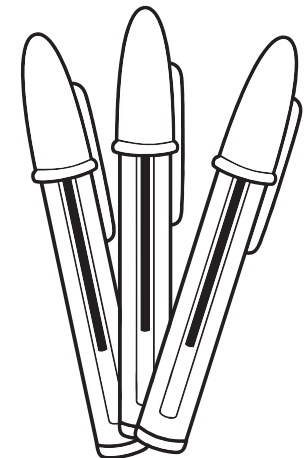

pens?

Name:

any



Trace the following word:

any any any any any



4 of my Flip Book sentences are:

1.

2.

3.

4.

Name _____

I am as slow as a

Glue/Staple

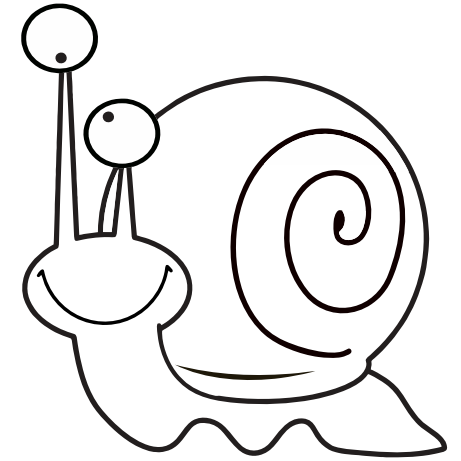

snail.

By Lavinia Pop © 2015

Glue/Staple



seahorse.

Glue/Staple

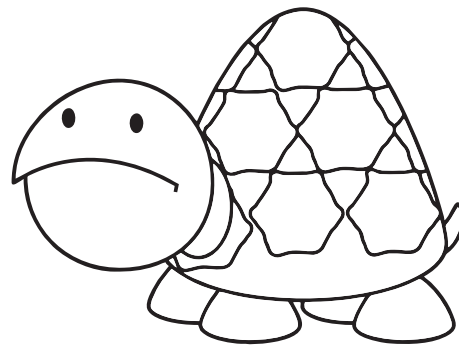

tortoise.

Glue/Staple

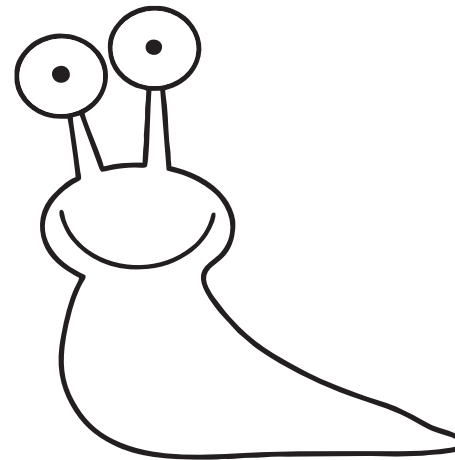

slug.



koala.

Name:

as



Trace the following word:

as as as as as



4 of my Flip Book sentences are:

1.

Blank handwriting lines for sentence 1.

2.

Blank handwriting lines for sentence 2.

3.

Blank handwriting lines for sentence 3.

4.

Blank handwriting lines for sentence 4.

Name _____

Ask him to open the

By Lavinia Pop © 2015

Glue/Staple

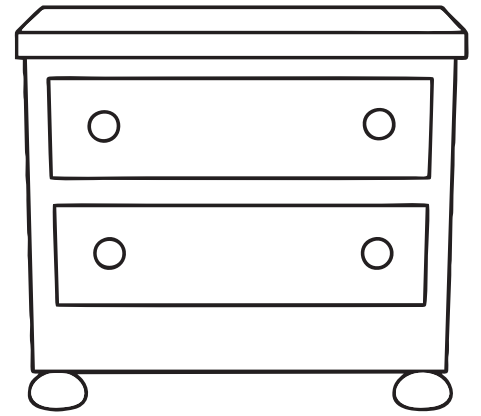

drawers.

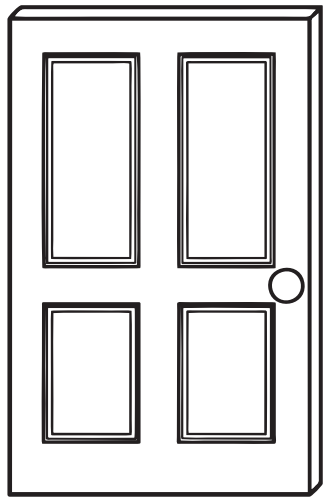

door.

Glue/Staple



jar.

Glue/Staple

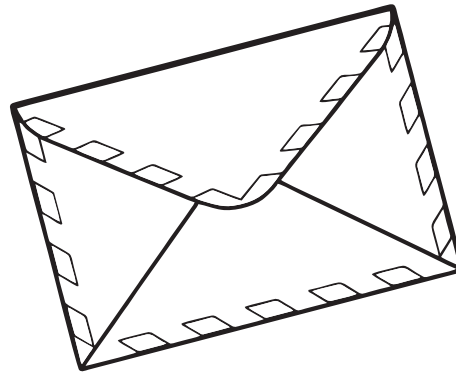

envelope.

Glue/Staple



window.

Name:

ask



Trace the following word:

ask ask ask ask ask



4 of my Flip Book sentences are:

1.

2.

3.

4.

Name _____

Glue/Staple

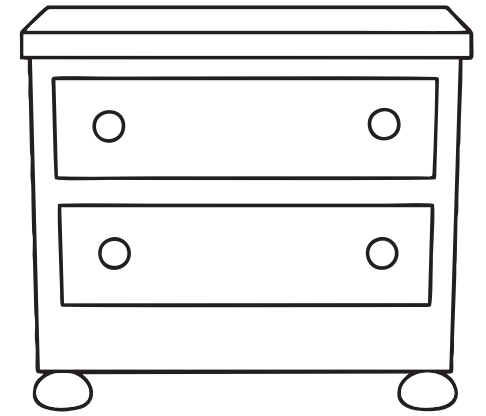

We need to buy a

dresser.

By Lavinia Pop © 2015

Glue/Staple

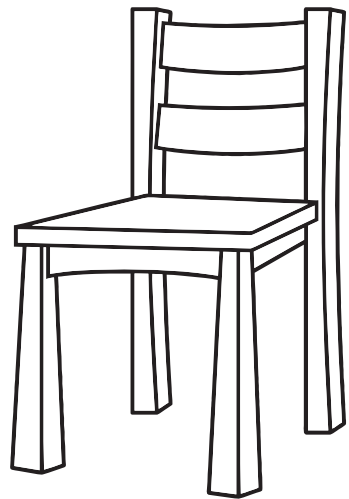

chair.

Glue/Staple

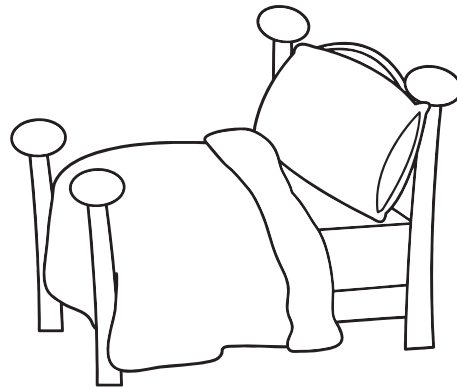

bed.

Glue/Staple

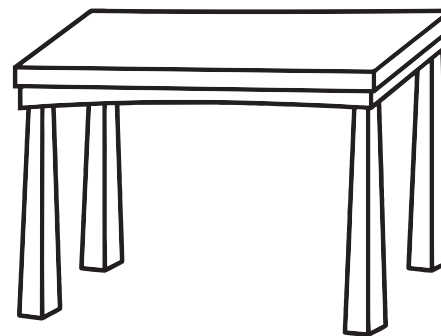
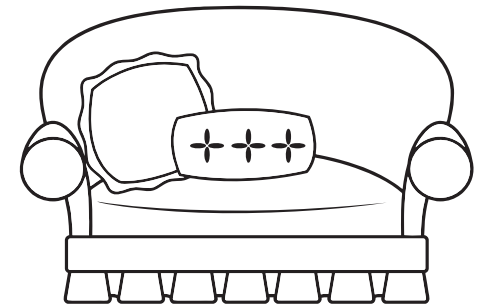

table.



sofa.

Name:

buy



Trace the following word:

buy buy buy buy buy



4 of my Flip Book sentences are:

1.

2.

3.

4.

Name _____

I could

By Lavinia Pop © 2015

Glue/Staple



hang.

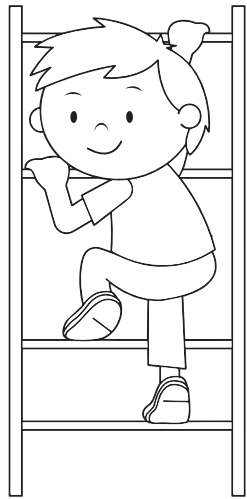

climb.

Glue/Staple



push.

Glue/Staple

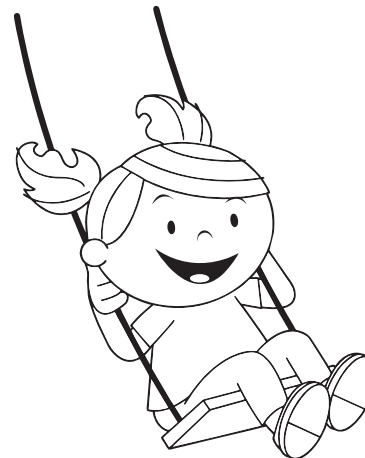

swing.

Glue/Staple

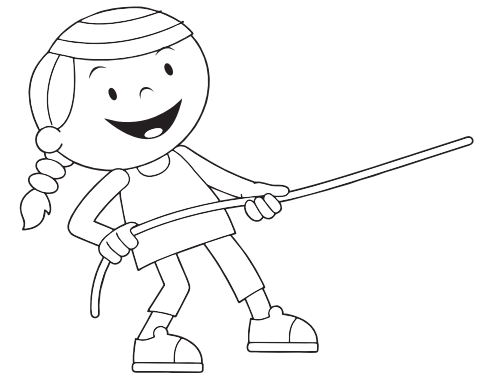

pull.

Name:

could



Trace the following word:

could could could could could



4 of my Flip Book sentences are:

1.

2.

3.

4.

She plays

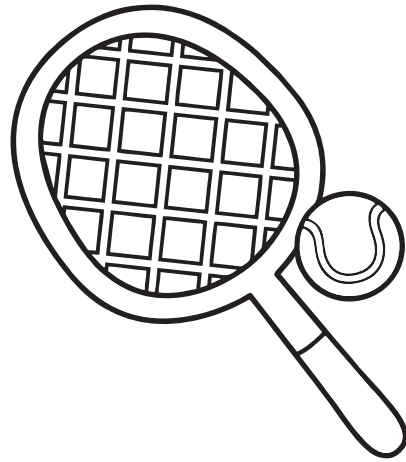

tennis

Glue/Staple

Name _____

every day.

By Lavinia Pop © 2015

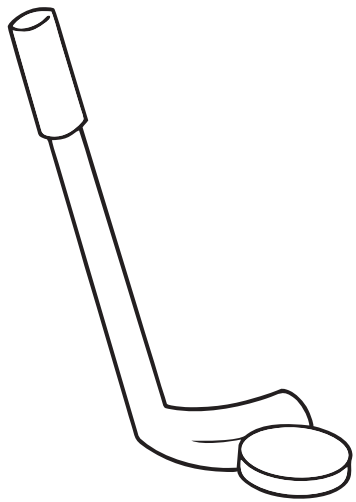

hockey

Glue/Staple



volleyball

Glue/Staple

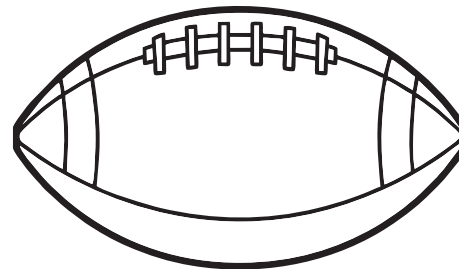

football

Glue/Staple



soccer

Name:

every



Trace the following word:

every every every every every



4 of my Flip Book sentences are:

1.

2.

3.

4.

Name _____

Glue/Staple

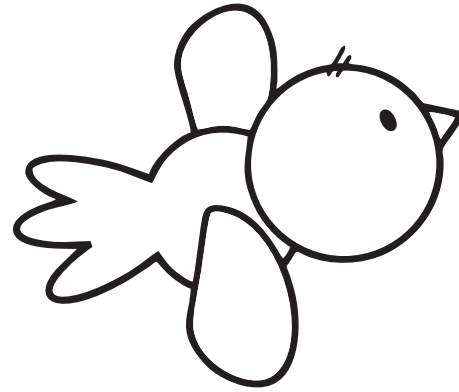

bird

fly!

Look at that

By Lavinia Pop © 2015

Glue/Staple

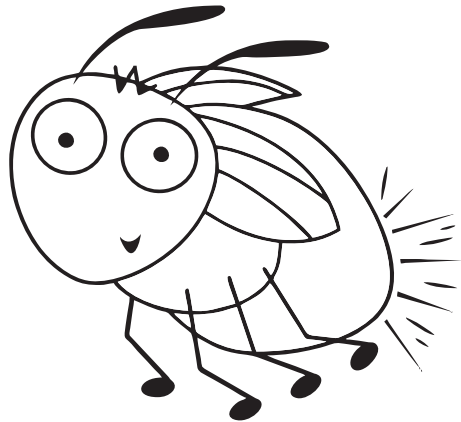

firefly

Glue/Staple

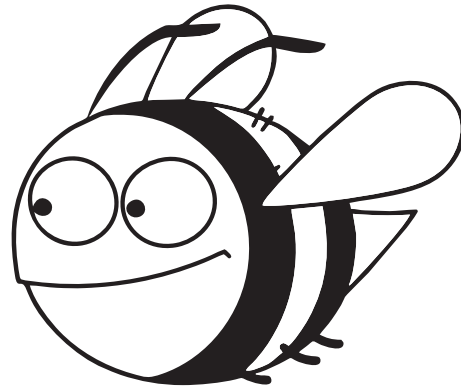

bee

Glue/Staple

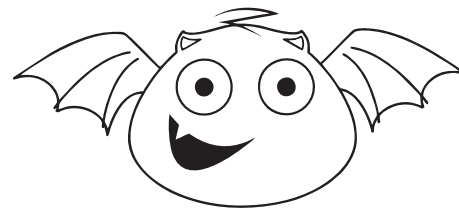

bat

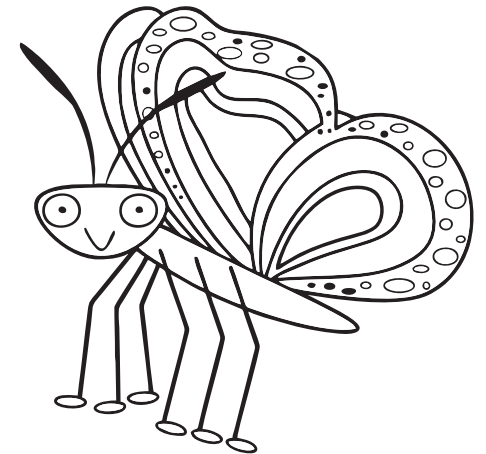

butterfly

Name:

fly



Trace the following word:

fly fly fly fly fly



4 of my Flip Book sentences are:

1.

2.

3.

4.

Glue/Staple



ball

Name _____

The

is from me.

By Lavinia Pop © 2015

Glue/Staple

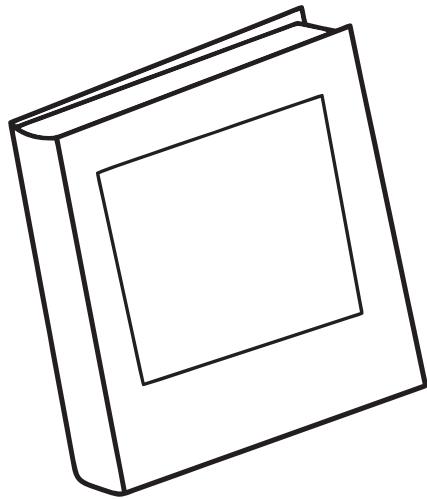

book

Glue/Staple

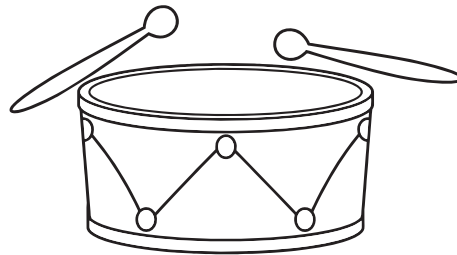

drum

Glue/Staple



bear

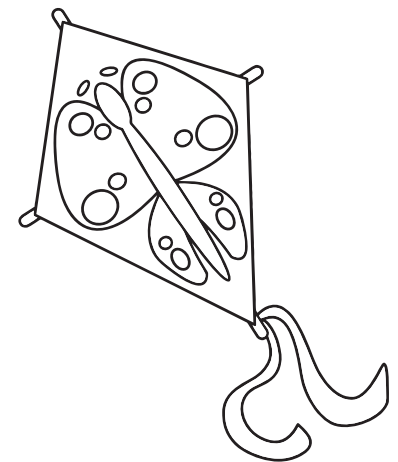

kite

Name:

from



Trace the following word:

from from from from from



4 of my Flip Book sentences are:

1.

2.

3.

4.

Name _____

Glue/Staple

I will give him a

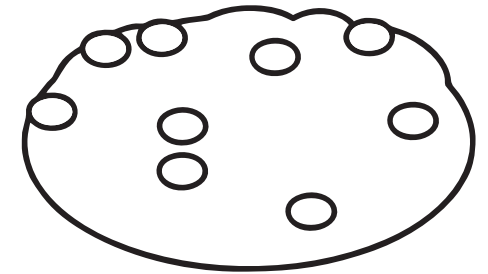

cookie.

By Lavinia Pop © 2015

Glue/Staple

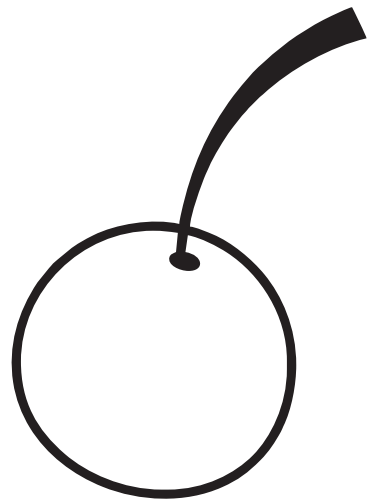

cherry.

Glue/Staple

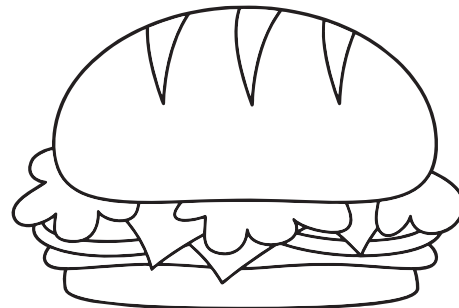

burger.

Glue/Staple

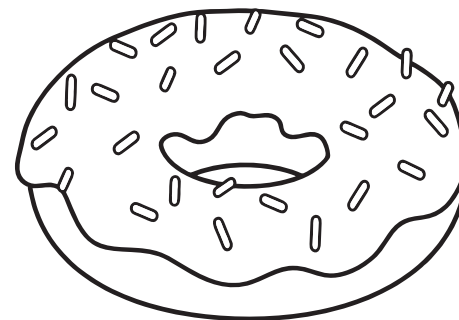

donut.



banana.

Name:

give



Trace the following word:

give give give give give



4 of my Flip Book sentences are:

1.

2.

3.

4.

Name _____

Glue/Staple

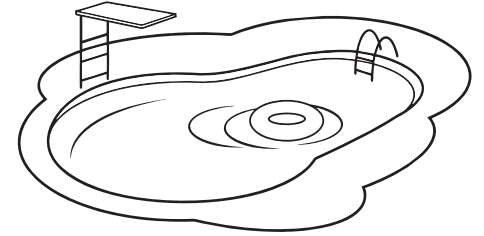

We are going to the

swimming
pool.

By Lavinia Pop © 2015

Glue/Staple



dentist.

Glue/Staple



police
station.

Glue/Staple

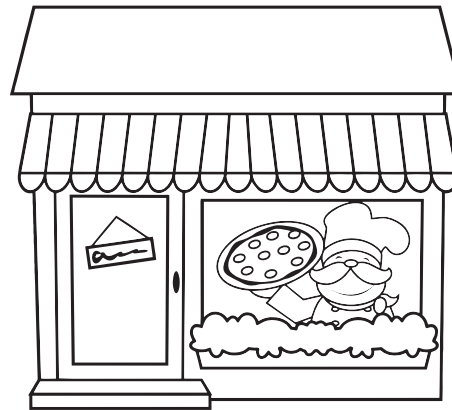

restaurant.



post
office.

Name:

going



Trace the following word:

going going going going going



4 of my Flip Book sentences are:

1.

2.

3.

4.

Name _____

Glue/Staple

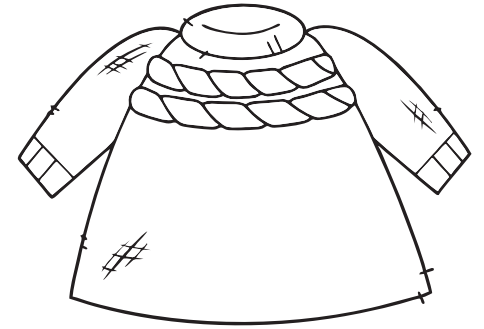

I had a blue

sweater.

By Lavinia Pop © 2015

Glue/Staple

Glue/Staple

Glue/Staple



ribbon.

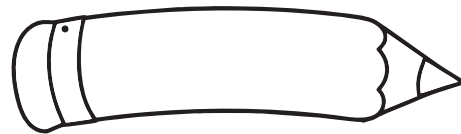

pencil.

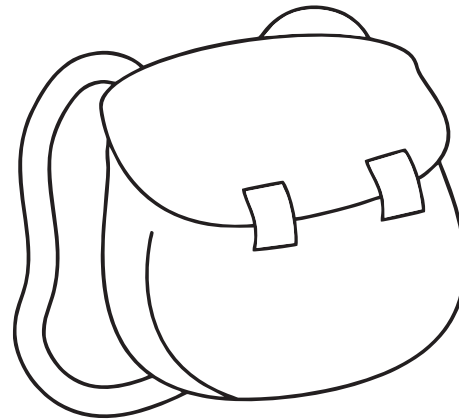

backpack.

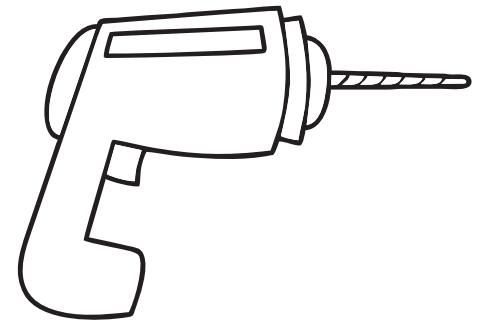

drill.

Name:

had



Trace the following word:

had had had had had



4 of my Flip Book sentences are:

1.

2.

3.

4.

Name _____

Glue/Staple



She has a green

desk.

By Lavinia Pop © 2015

Glue/Staple

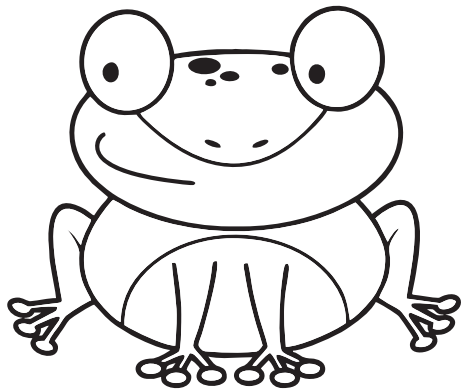

frog.

Glue/Staple

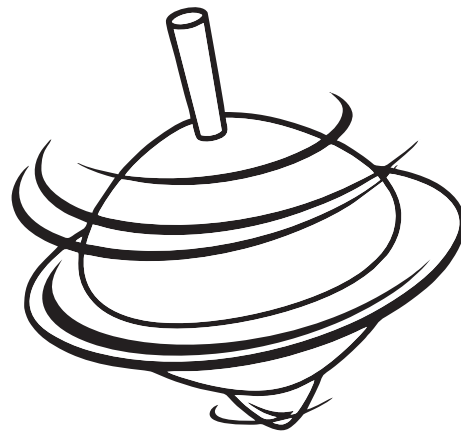

top.

Glue/Staple

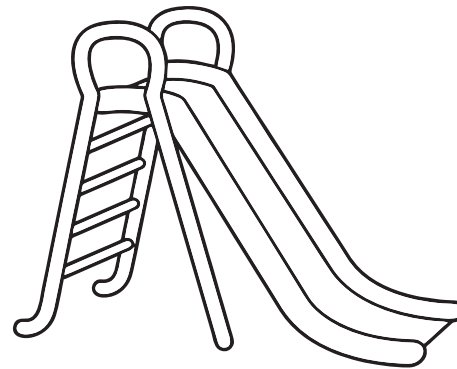

slide.

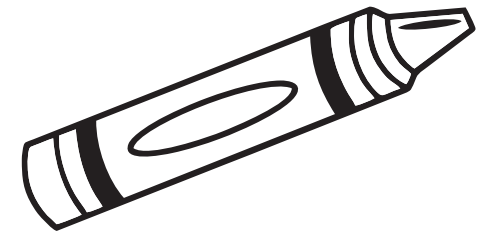

crayon.

Name:

has



Trace the following word:

has has has has has



4 of my Flip Book sentences are:

1.

2.

3.

4.

Name _____

That is her

By Lavinia Pop © 2015

Glue/Staple

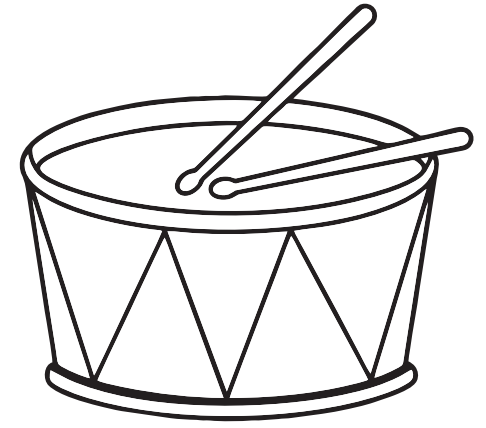

drum.

Glue/Staple

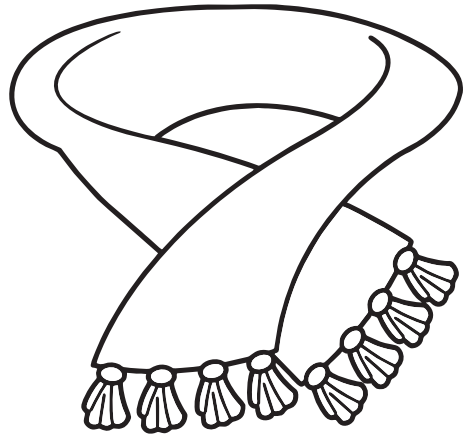

scarf.

Glue/Staple

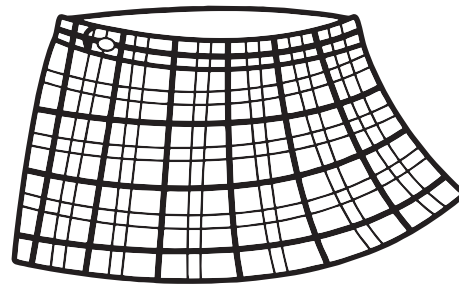

skirt.

Glue/Staple



dog.

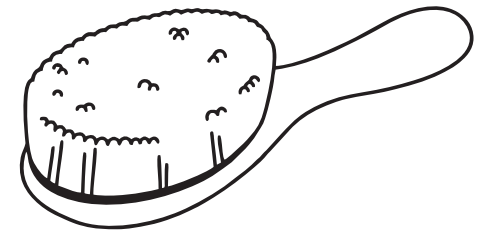

brush.

Name:

her



Trace the following word:

her her her her her



4 of my Flip Book sentences are:

1.

2.

3.

4.

Name _____

Glue/Staple

Can you see him

By Lavinia Pop © 2015



ride?

Glue/Staple

Glue/Staple

Glue/Staple



swing?



run?



sweep?



juggle?

Name:

him



Trace the following word:

him him him him him



4 of my Flip Book sentences are:

1.

2.

3.

4.

Name _____

Glue/Staple

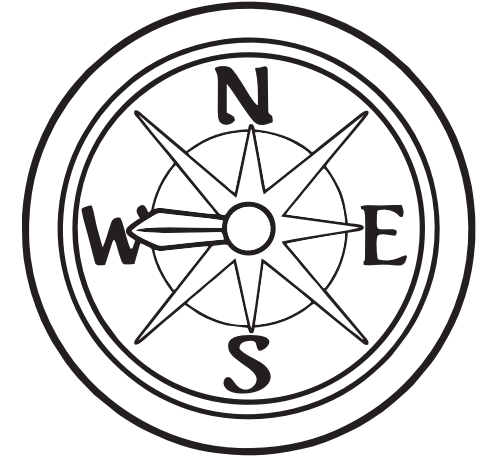

compass.

That is his

By Lavinia Pop © 2015

Glue/Staple

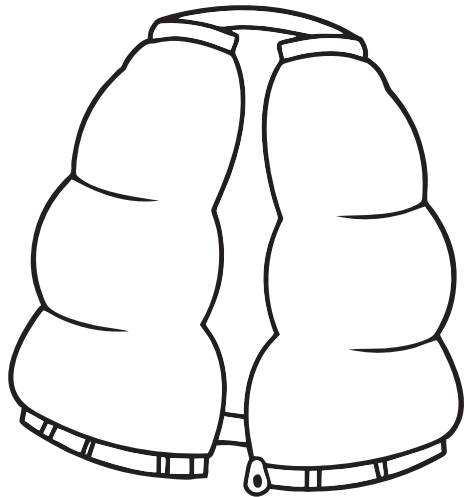

vest.

Glue/Staple

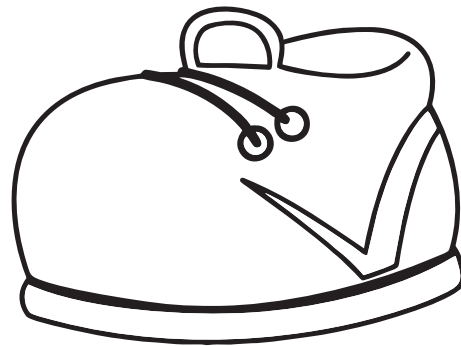

shoe.

Glue/Staple

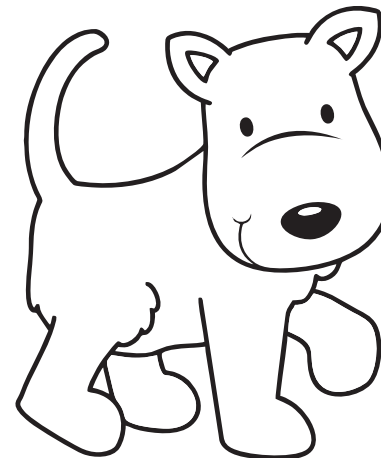

dog.

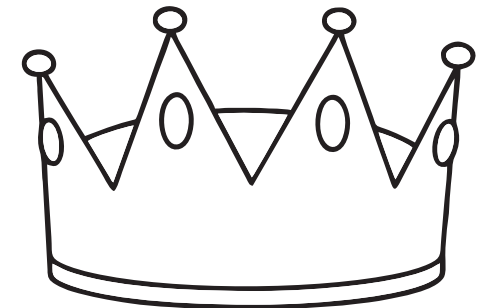

crown.

Name:

his



Trace the following word:

his his his his his



4 of my Flip Book sentences are:

1.

2.

3.

4.

Name _____

How will I get
to the

By Lavinia Pop © 2015

Glue/Staple

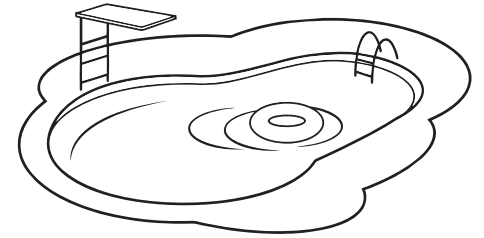

swimming
pool?



dentist?

Glue/Staple



police
station?

Glue/Staple

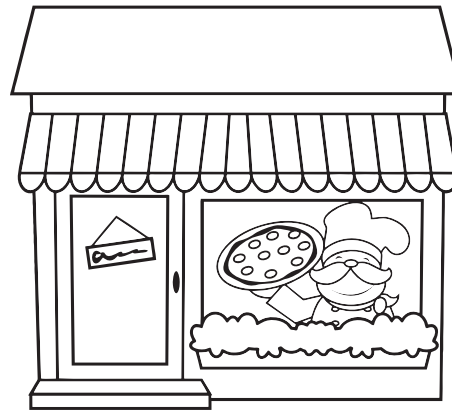

restaurant?

Glue/Staple



post
office?

Name:

how



Trace the following word:

how how how how how



4 of my Flip Book sentences are:

1.

2.

3.

4.

Name _____

I just want
to see the

By Lavinia Pop © 2015

Glue/Staple

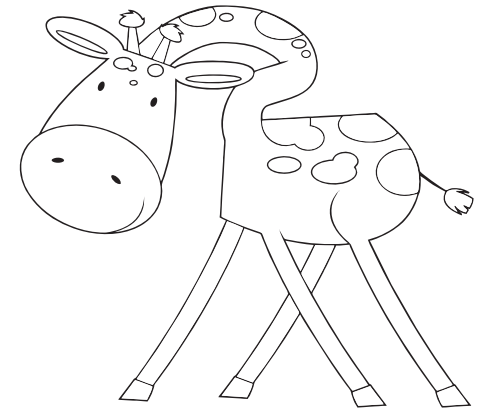

giraffe!

Glue/Staple

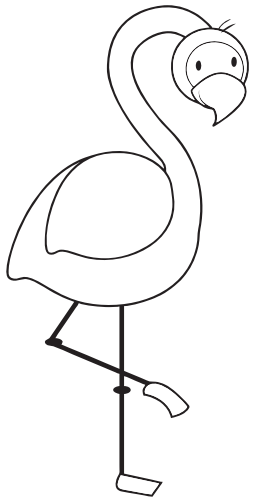

flamingo!

Glue/Staple

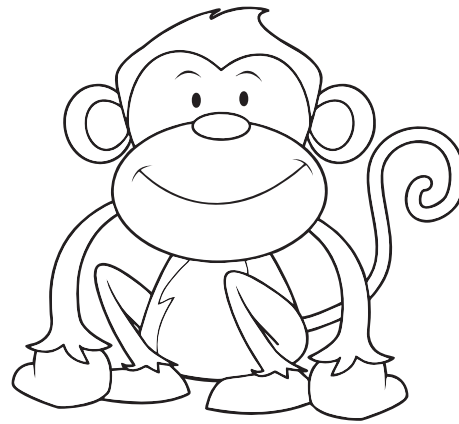

monkey!

Glue/Staple

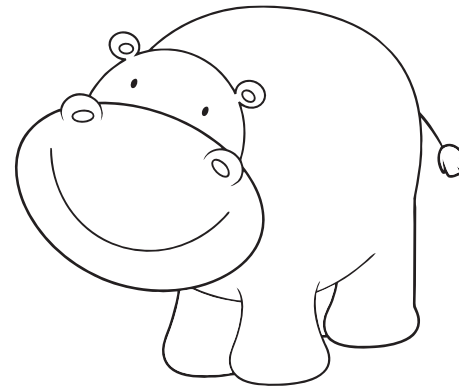

hippo!



tiger!

Name:

just



Trace the following word:

just just just just just



4 of my Flip Book sentences are:

1.

2.

3.

4.

Name _____

Do you know
where the

Glue/Staple

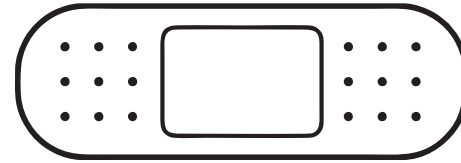

bandage

is?

By Lavinia Pop © 2015

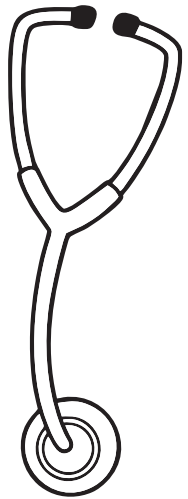

Glue/Staple



Glue/Staple



Glue/Staple

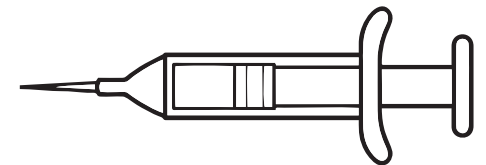

stethoscope

thermometer

medicine

syringe

Name:

know



Trace the following word:

know know know know know



4 of my Flip Book sentences are:

1.

2.

3.

4.

Name _____

Glue/Staple

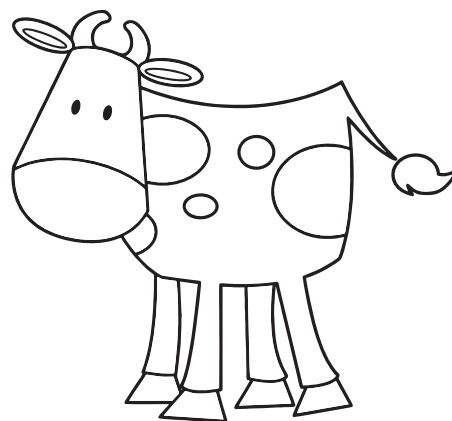

cow

Let the

come in.

By Lavinia Pop © 2015

Glue/Staple

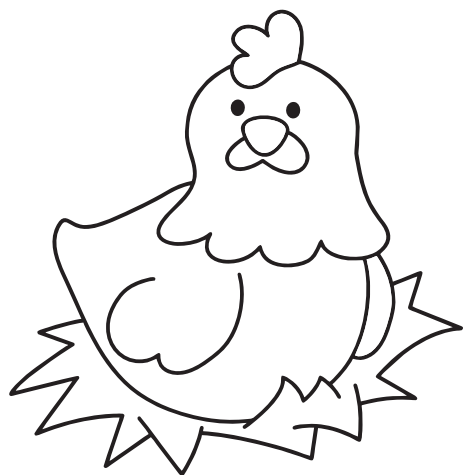

hen

Glue/Staple

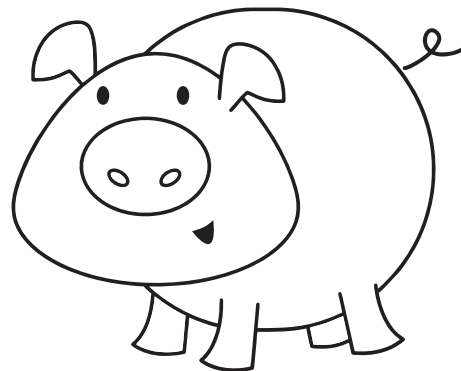

pig

Glue/Staple

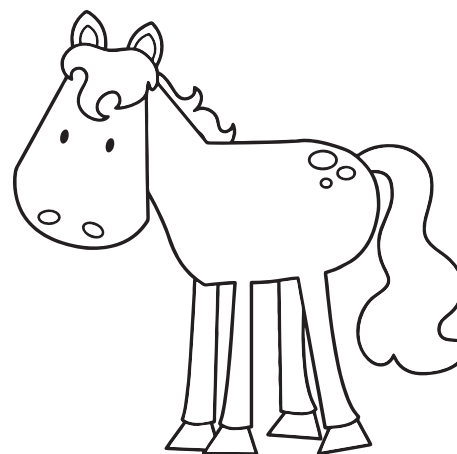

horse

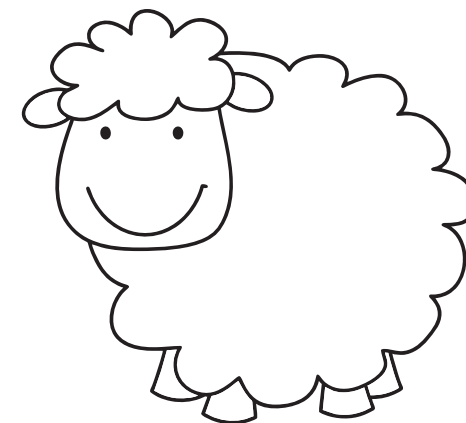

sheep

Name:

let



Trace the following word:

let let let let let



4 of my Flip Book sentences are:

1.

2.

3.

4.

Glue/Staple

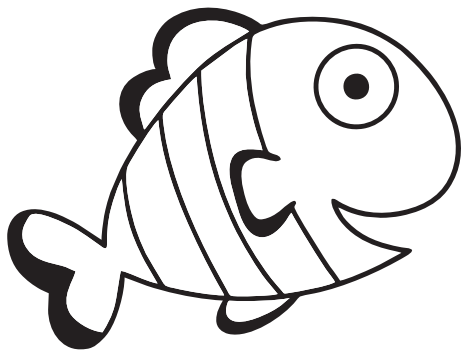

Fish

Name _____

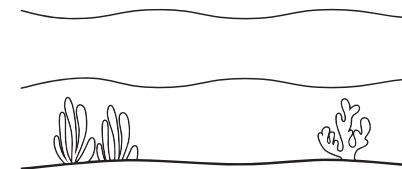

live in the ocean.

By Lavinia Pop © 2015

Glue/Staple



Seahorses

Glue/Staple

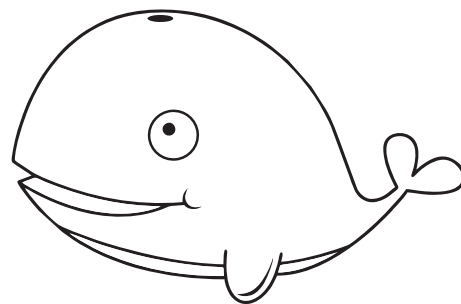

Whales

Glue/Staple

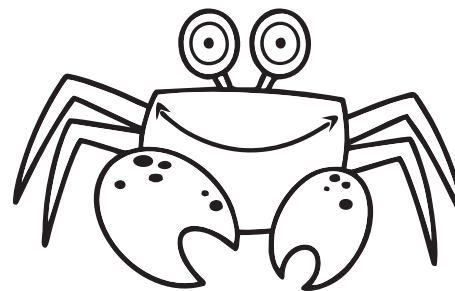

Crabs

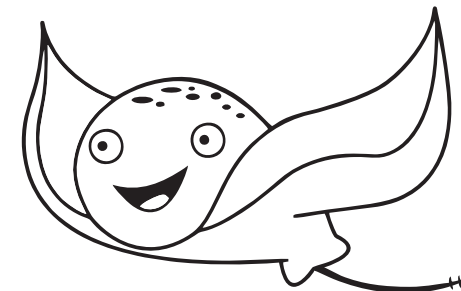

Stingrays

Name:

live



Trace the following word:

live live live live live



4 of my Flip Book sentences are:

1.

2.

3.

4.

Name _____

I made a

Glue/Staple

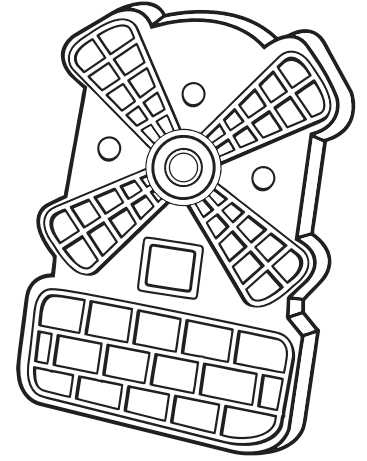

cookie.

By Lavinia Pop © 2015

Glue/Staple



card.

Glue/Staple



gingerbread
man.

Glue/Staple

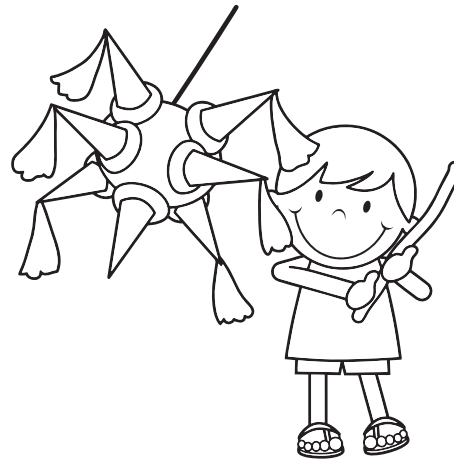

pinata.

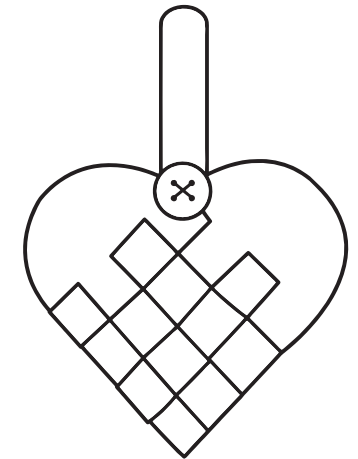

decoration.

Name:

made



Trace the following word:

made made made made made



4 of my Flip Book sentences are:

1.

2.

3.

4.

Name _____

May I please
have some

By Lavinia Pop © 2015

Glue/Staple

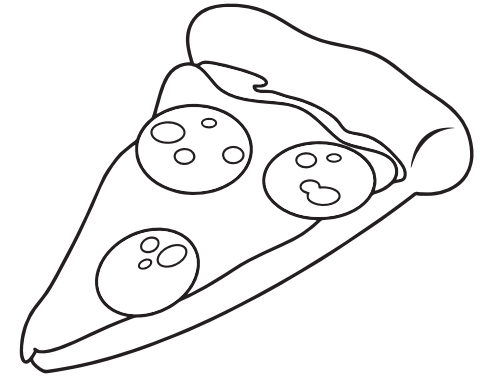

pizza?

Glue/Staple



ice cream?

Glue/Staple

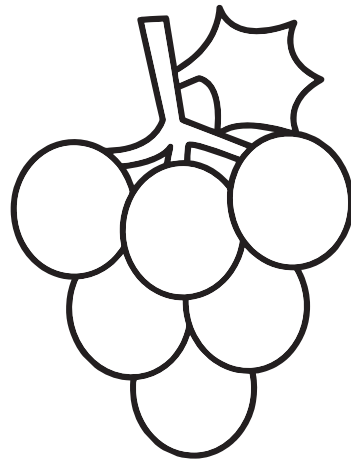

grapes?

Glue/Staple

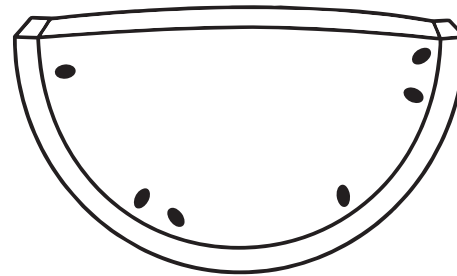

watermelon?

Glue/Staple

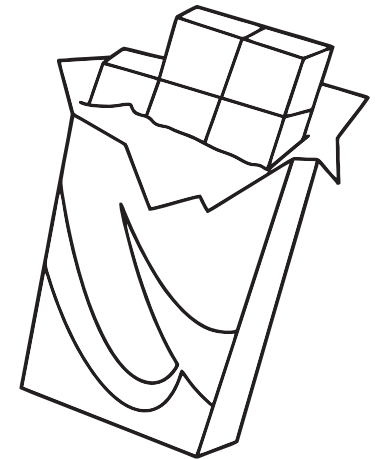

chocolate?

Name:

may



Trace the following word:

may may may may may



4 of my Flip Book sentences are:

1.

2.

3.

4.

Name _____

Glue/Staple



van.

I got out of the

By Lavinia Pop © 2015

Glue/Staple

Glue/Staple

Glue/Staple

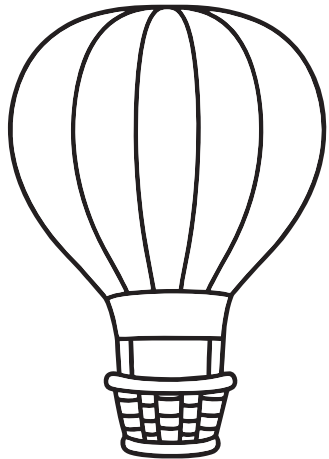

hot air
balloon.

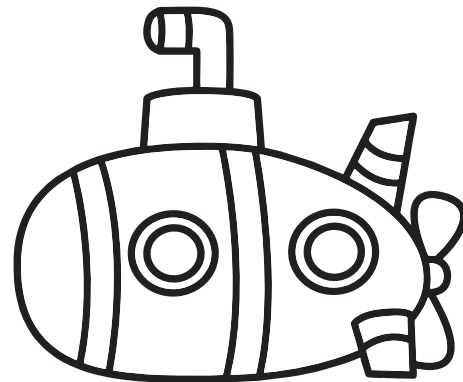

submarine.

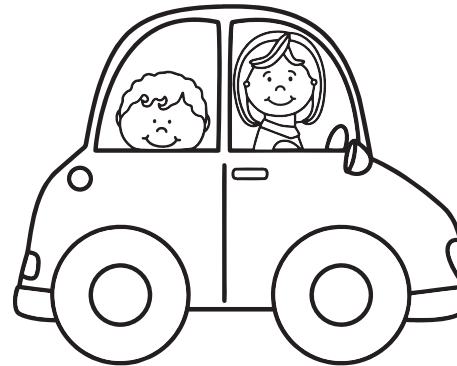

car.

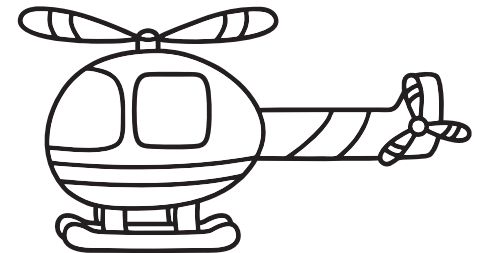

helicopter.

Name:

of



Trace the following word:

of of of of of



4 of my Flip Book sentences are:

1.

2.

3.

4.

Name _____

Glue/Staple



granddad?

How old is your

By Lavinia Pop © 2015

Glue/Staple

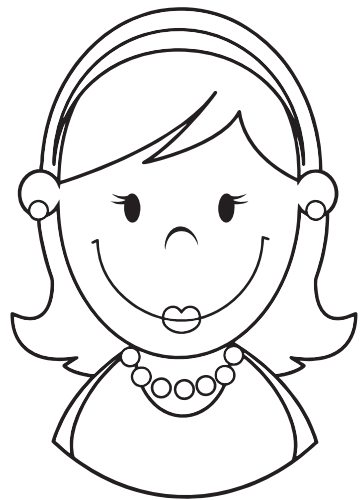

mom?

Glue/Staple

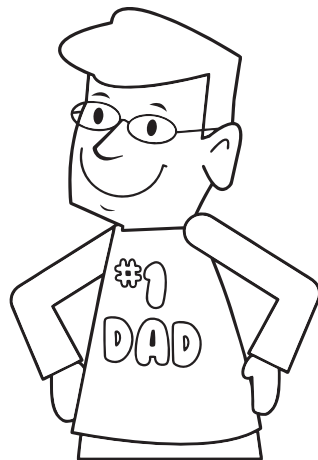

dad?

Glue/Staple



sister?



brother?

Name:

old



Trace the following word:

old old old old old



4 of my Flip Book sentences are:

1.

2.

3.

4.

Name _____

Glue/Staple

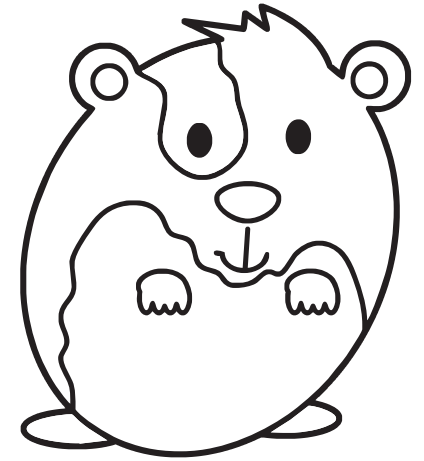

hamster.

We once had a pet

By Lavinia Pop © 2015

Glue/Staple



dog.

Glue/Staple

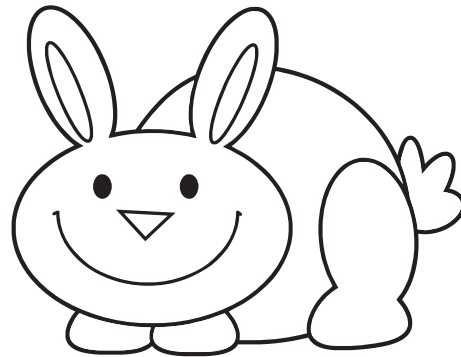

rabbit.

Glue/Staple

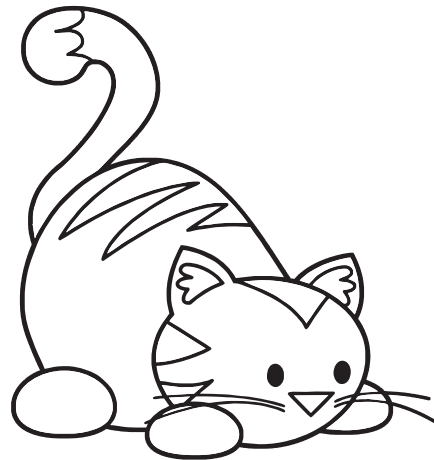

cat.

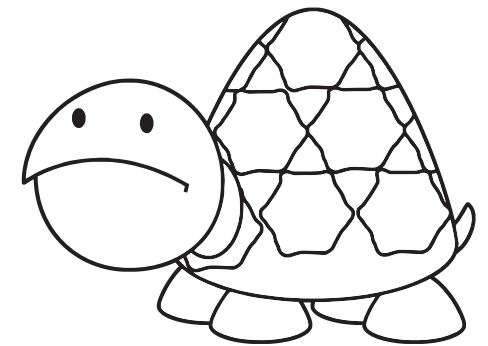

turtle.

Name:

once



Trace the following word:

once once once once once



4 of my Flip Book sentences are:

1.

2.

3.

4.

Name _____

Please open the

By Lavinia Pop © 2015

Glue/Staple

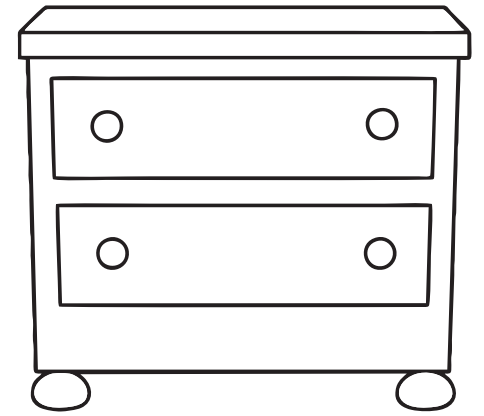

drawers.

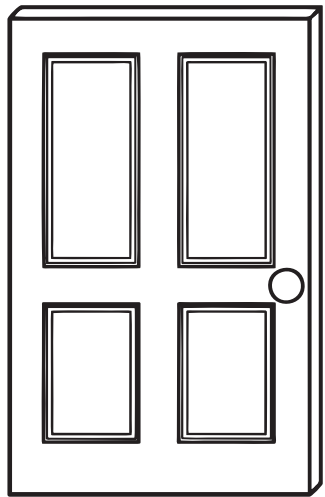

door.

Glue/Staple



jar.

Glue/Staple

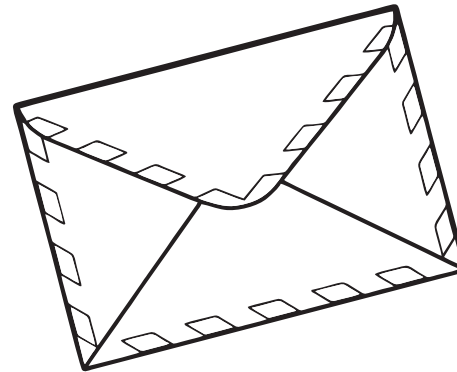

envelope.

Glue/Staple



window.

Name:

open



Trace the following word:

open open open open open



4 of my Flip Book sentences are:

1.

2.

3.

4.

Name _____

He can jump
over the

By Lavinia Pop © 2015

Glue/Staple

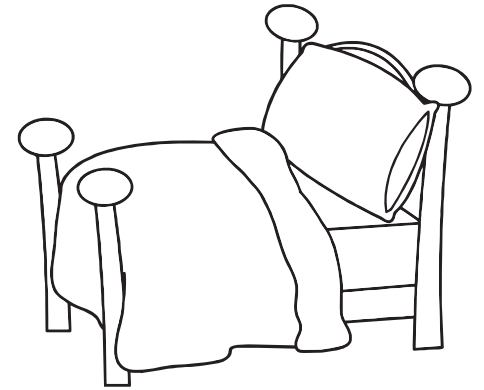

bed.

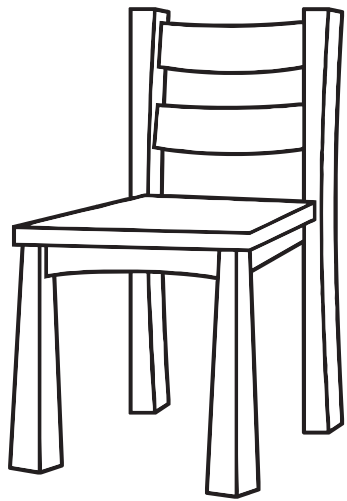

chair.

Glue/Staple

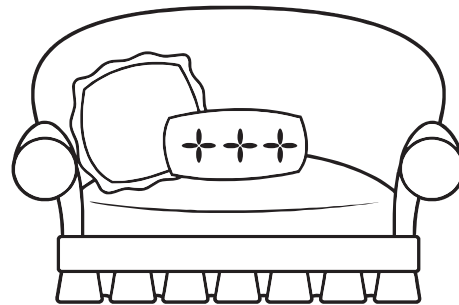

sofa.

Glue/Staple

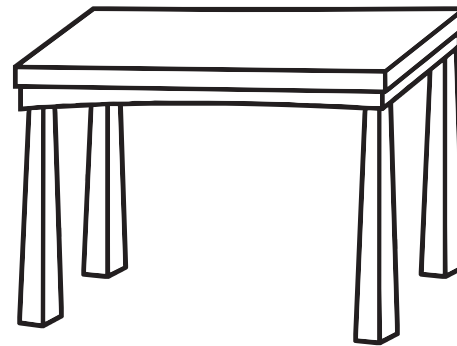
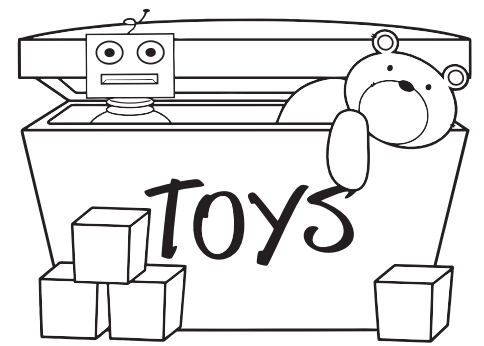

table.

Glue/Staple



toy box.

Name:

over



Trace the following word:

over over over over over



4 of my Flip Book sentences are:

1.

2.

3.

4.

Name _____

Glue/Staple

I put on my



sneakers.

By Lavinia Pop © 2015

Glue/Staple



socks.

Glue/Staple

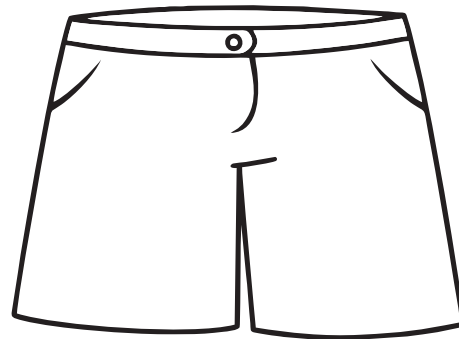

shorts.

Glue/Staple

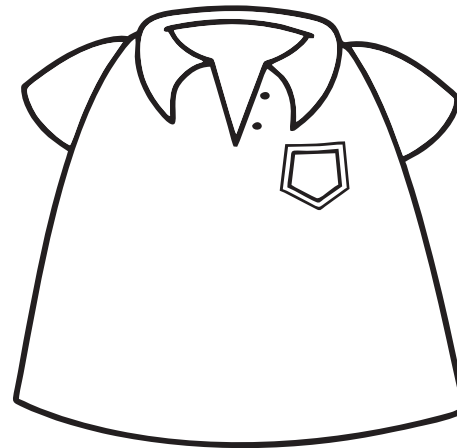

t-shirt.

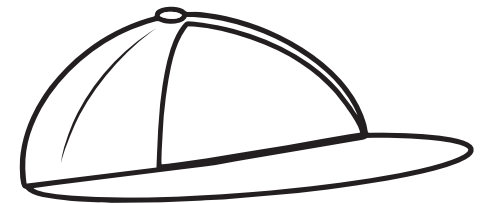

cap.

Name:

put



Trace the following word:

put put put put put



4 of my Flip Book sentences are:

1.

2.

3.

4.

Name _____

Glue/Staple

I have a round

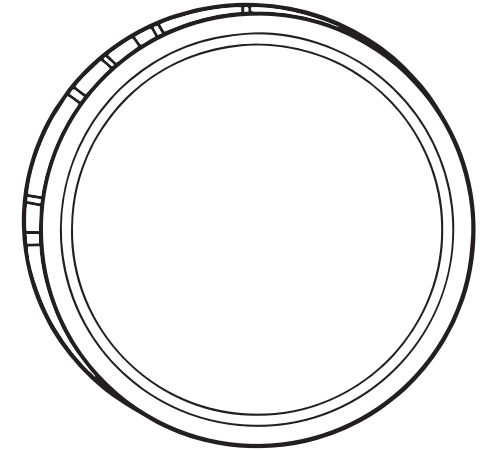

coin.

By Lavinia Pop © 2015

Glue/Staple

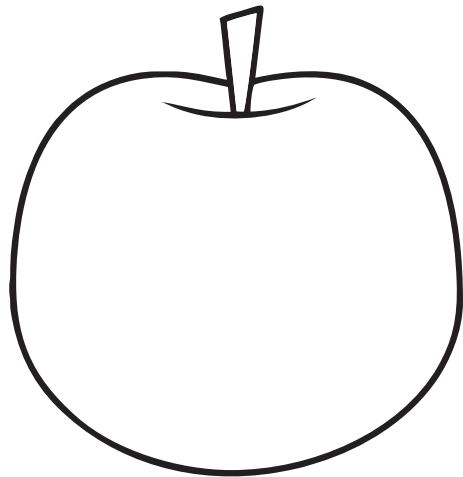

apple.

Glue/Staple

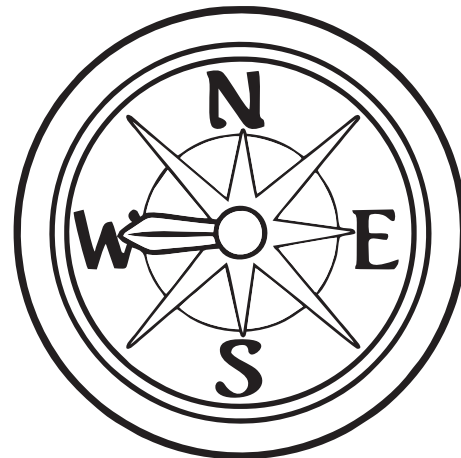

compass.

Glue/Staple

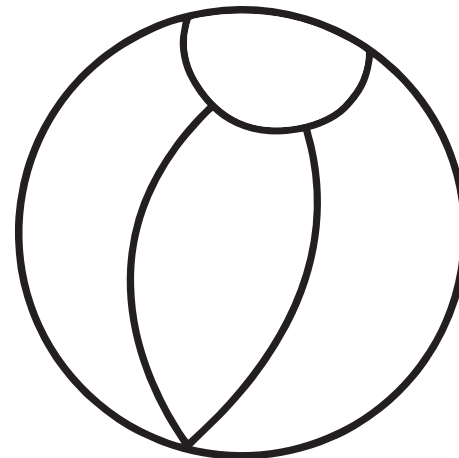

ball.

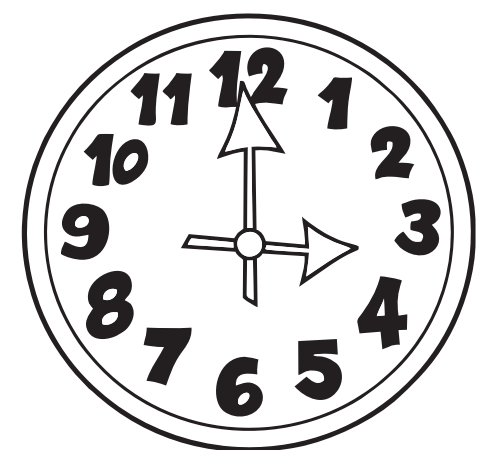

clock.

Name:

round



Trace the following word:

round round round round round



4 of my Flip Book sentences are:

1.

2.

3.

4.

Name _____

There are some
apples in the

By Lavinia Pop © 2015

Glue/Staple

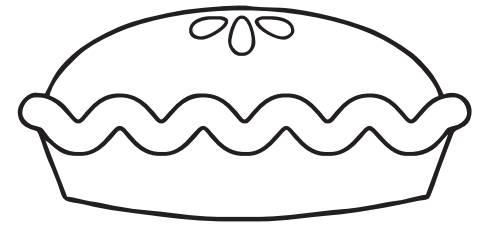

pie.

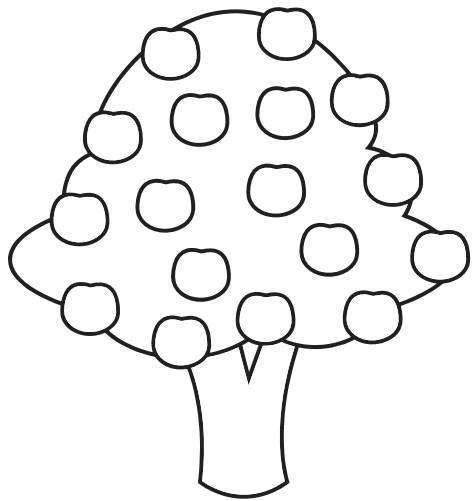

orchard.

Glue/Staple



basket.

Glue/Staple



crate.

Glue/Staple

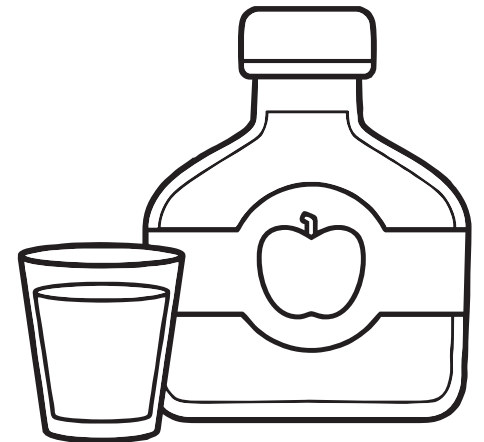

juice.

Name:

some



Trace the following word:

some some some some some



4 of my Flip Book sentences are:

1.

2.

3.

4.

Name _____

Glue/Staple

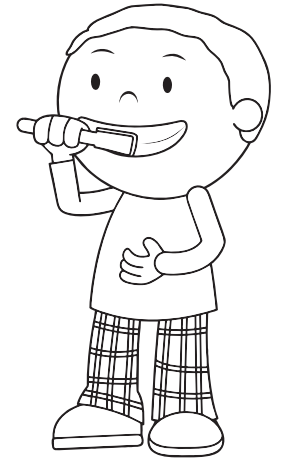

When will you stop

brushing?

By Lavinia Pop © 2015

Glue/Staple

Glue/Staple

Glue/Staple



wiggling?



dancing?



digging?



clapping?

Name:

stop



Trace the following word:

stop stop stop stop stop



4 of my Flip Book sentences are:

1.

2.

3.

4.

Name _____

Glue/Staple

Did you take my



pencil?

By Lavinia Pop © 2015

Glue/Staple

Glue/Staple

Glue/Staple

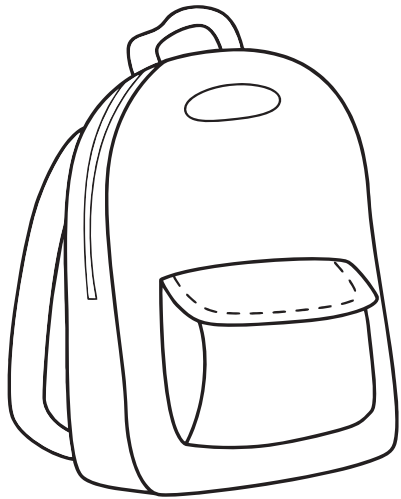

backpack?

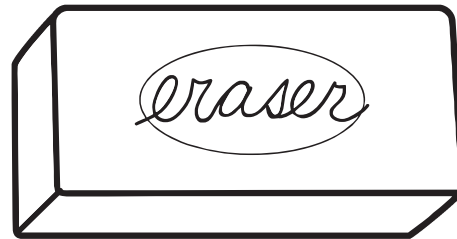

eraser?

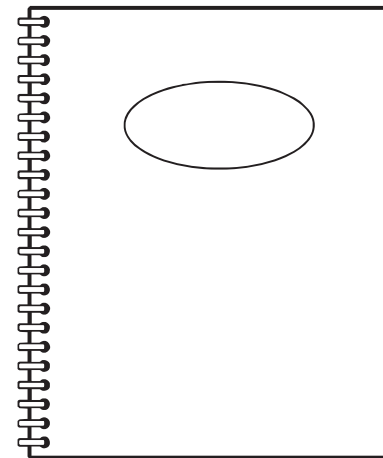

notebook?

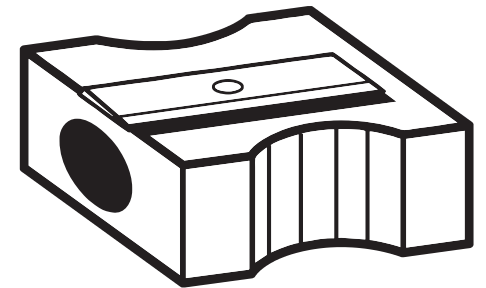

sharpener?

Name:

take



Trace the following word:

take take take take take



4 of my Flip Book sentences are:

1.

2.

3.

4.

Name _____

Thank you for the

By Lavinia Pop © 2015

Glue/Staple

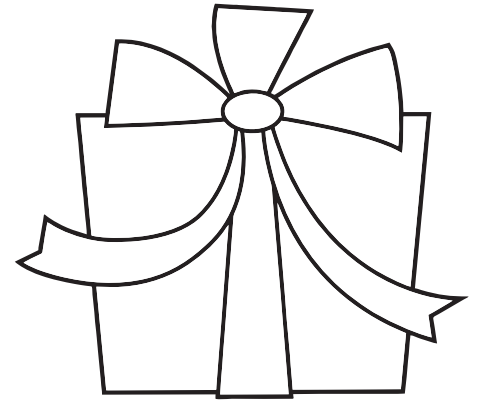

present.

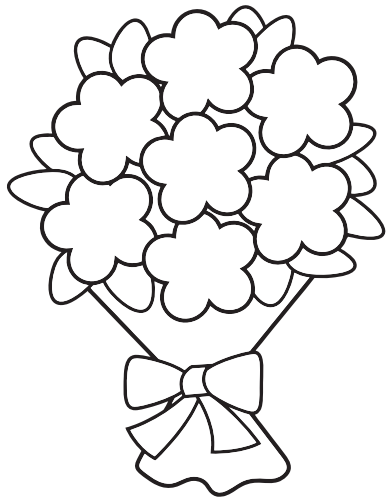

flowers.

Glue/Staple

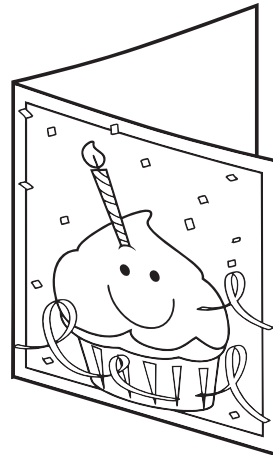

card.

Glue/Staple

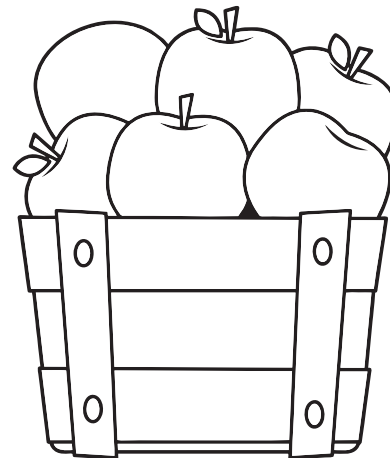

apples.

Glue/Staple

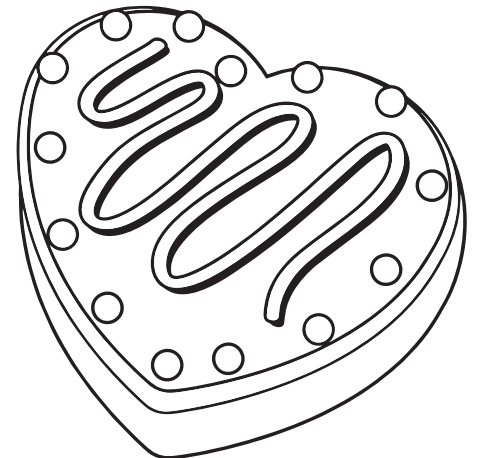

cookie.

Name:

thank



Trace the following word:

thank thank thank thank thank



4 of my Flip Book sentences are:

1.

2.

3.

4.

Name _____

Glue/Staple

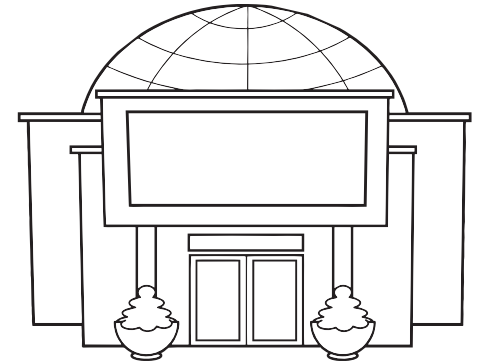

I saw them at the

museum.

By Lavinia Pop © 2015

Glue/Staple



post
office.

Glue/Staple

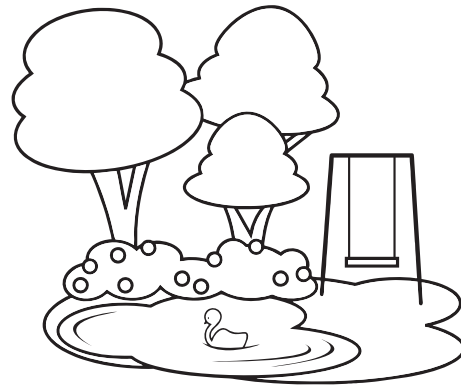

park.

Glue/Staple

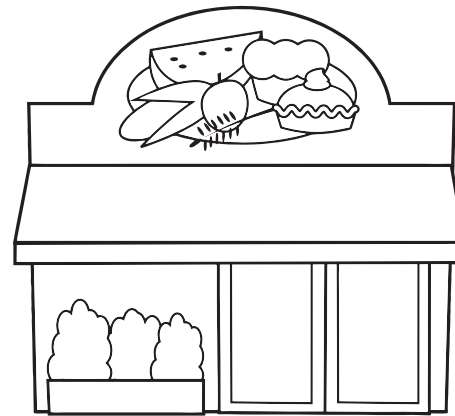

store.

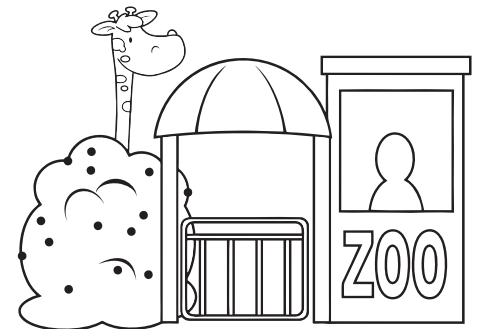

zoo.

Name:

them



Trace the following word:

them them them them them



4 of my Flip Book sentences are:

1.

2.

3.

4.

Name _____

I will go home,
then I will

By Lavinia Pop © 2015

Glue/Staple



sleep.



eat.

Glue/Staple



play.

Glue/Staple



read.

Glue/Staple



draw.

Name:

then



Trace the following word:

then then then then then



4 of my Flip Book sentences are:

1.

2.

3.

4.

Name _____

What do you
think is in the

By Lavinia Pop © 2015

Glue/Staple

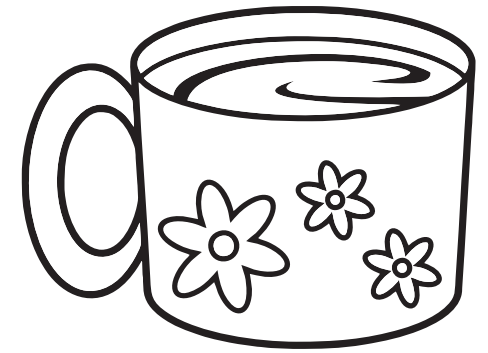

mug?

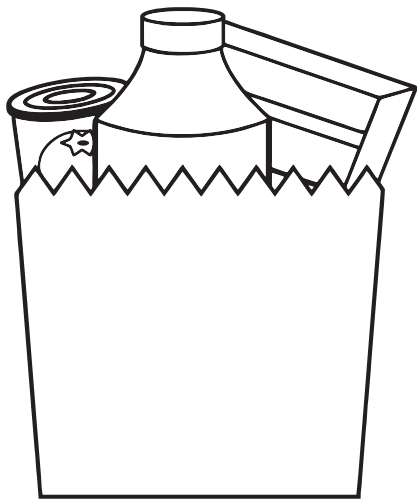

bag?

Glue/Staple

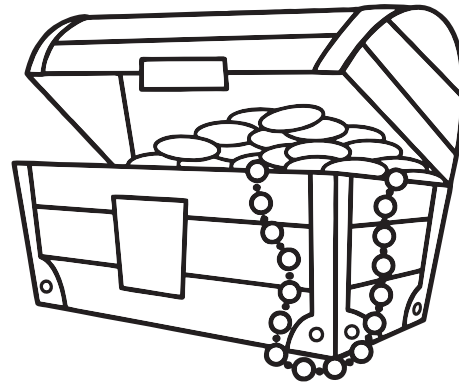

chest?

Glue/Staple

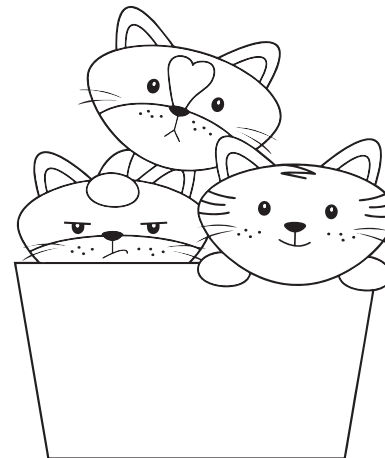

box?

Glue/Staple

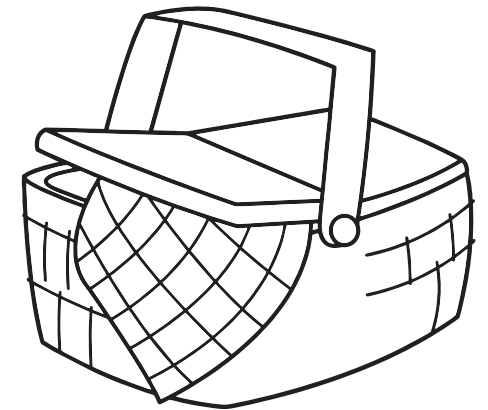

basket?

Name:

think



Trace the following word:

think think think think think



4 of my Flip Book sentences are:

1.

2.

3.

4.

Glue/Staple

Name _____

Is the

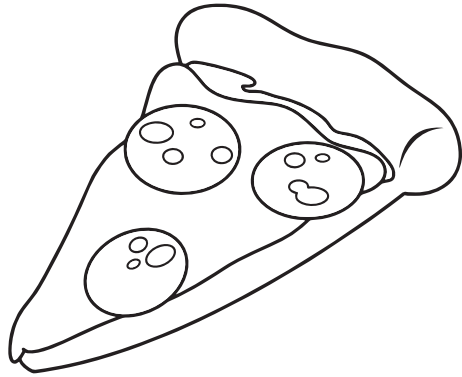

pizza

for us?

By Lavinia Pop © 2015

Glue/Staple

Glue/Staple

Glue/Staple



ice cream

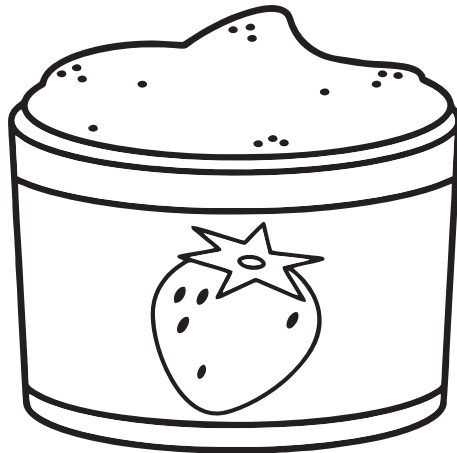

yogurt

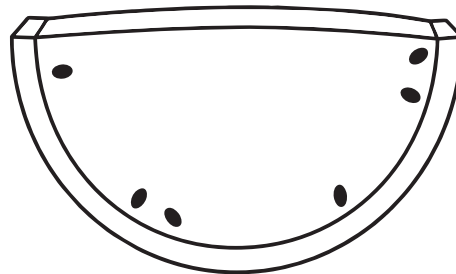

watermelon

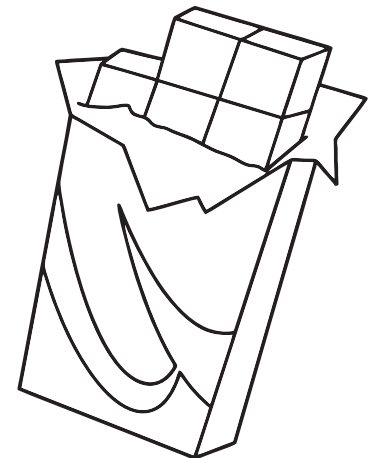

chocolate

Name:

us



Trace the following word:

us us us us us



4 of my Flip Book sentences are:

1.

Blank handwriting lines for sentence 1.

2.

Blank handwriting lines for sentence 2.

3.

Blank handwriting lines for sentence 3.

4.

Blank handwriting lines for sentence 4.

Name _____

I will walk my pet

By Lavinia Pop © 2015

Glue/Staple

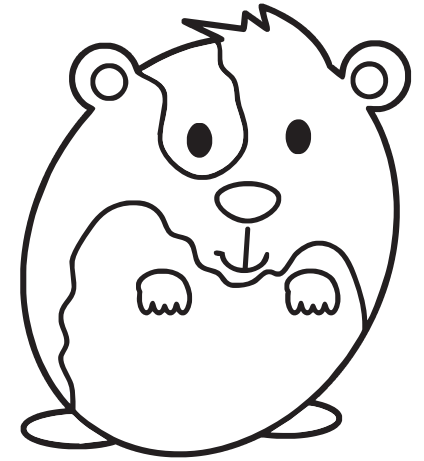

hamster.



dog.

Glue/Staple

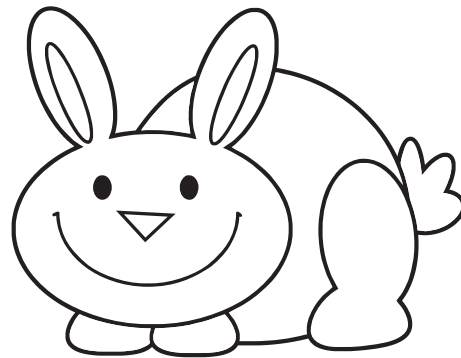

rabbit.

Glue/Staple

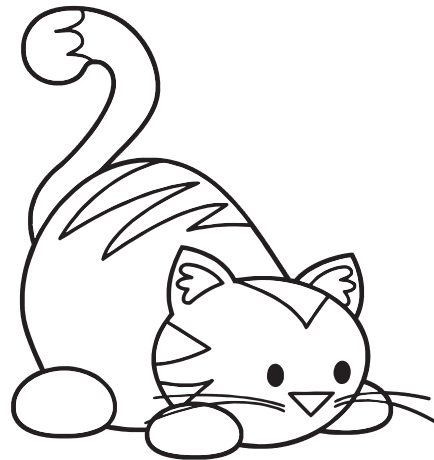

cat.

Glue/Staple

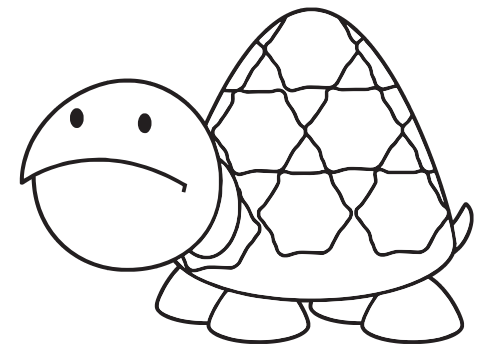

turtle.

Name:

walk



Trace the following word:

walk walk walk walk walk



4 of my Flip Book sentences are:

1.

2.

3.

4.

Name _____

Were you playing

By Lavinia Pop © 2015

Glue/Staple

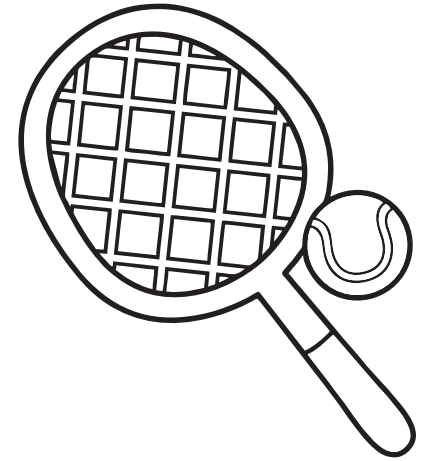

tennis?

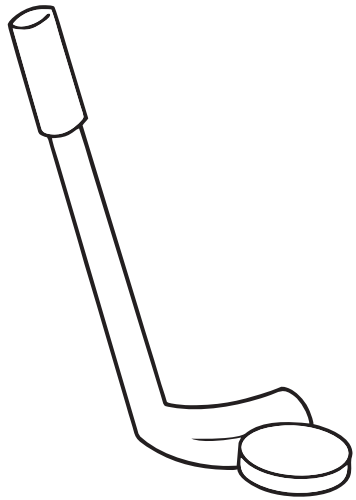

hockey?

Glue/Staple



volleyball?

Glue/Staple

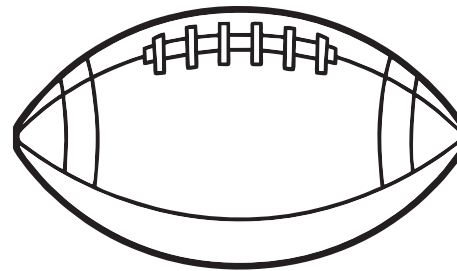

football?

Glue/Staple



soccer?

Name:

were



Trace the following word:

were were were were were



4 of my Flip Book sentences are:

1.

2.

3.

4.

Name _____

When did they
go to the

By Lavinia Pop © 2015

Glue/Staple

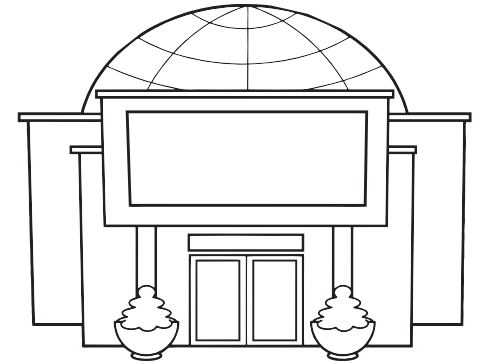

museum?

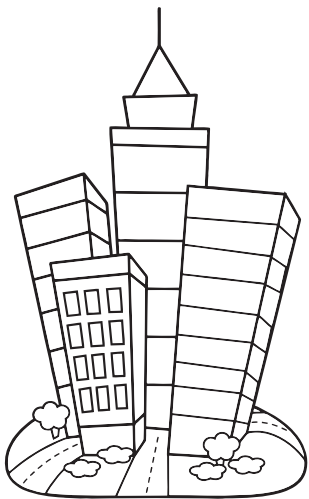

city?

Glue/Staple

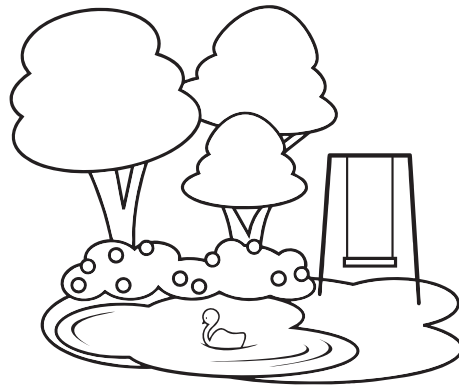

park?

Glue/Staple

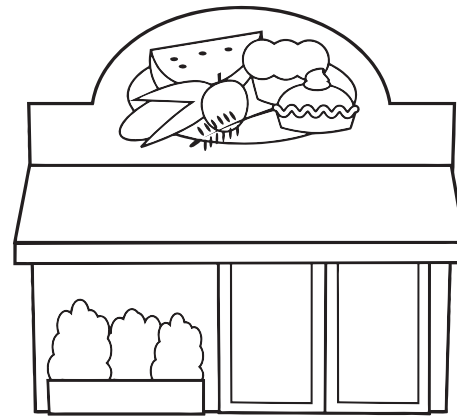

store?

Glue/Staple

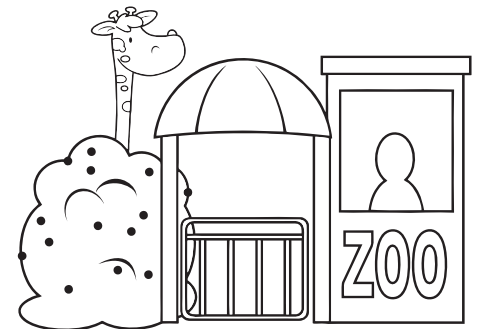

zoo?

Name:

when



Trace the following word:

when when when when when



4 of my Flip Book sentences are:

1.

2.

3.

4.

Name _____

Glue/Staple

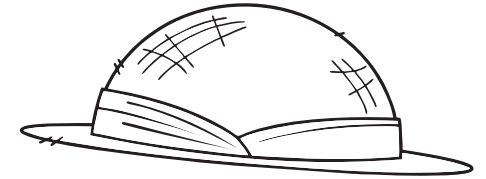

Where is your
hat?

By Lavinia Pop © 2015

Glue/Staple

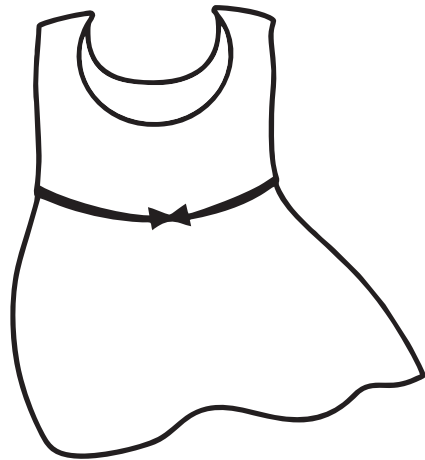

dress?

Glue/Staple

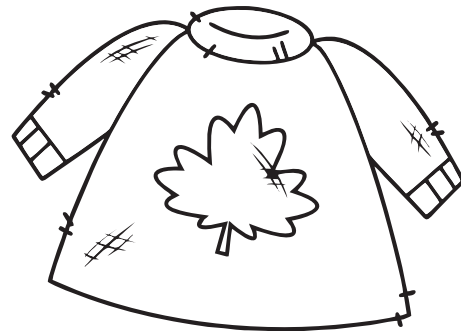

sweater?

Glue/Staple

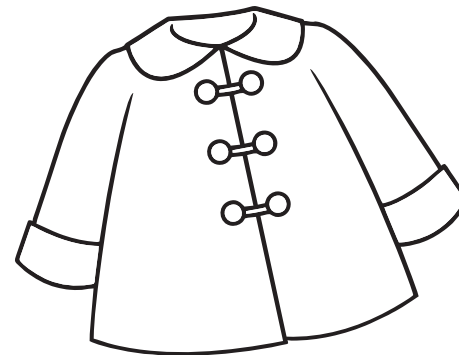

coat?



shirt?

Name:

your



Trace the following word:

your your your your your



4 of my Flip Book sentences are:

1.

2.

3.

4.

Glue/Staple



The

mouse

Name _____

ran **after** us.

By Lavinia Pop © 2015

Glue/Staple



dog

Glue/Staple

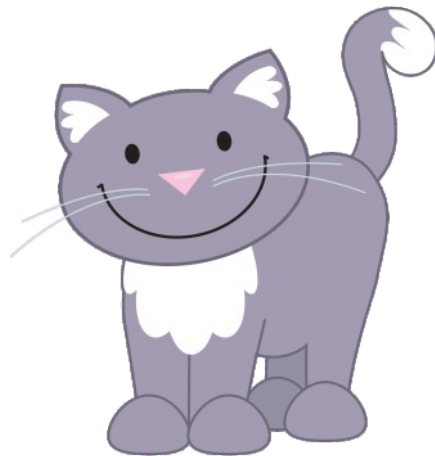

cat

Glue/Staple

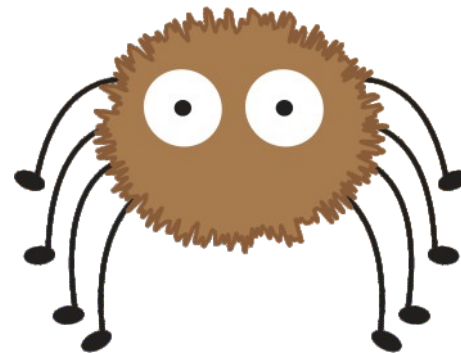

spider



hamster

Is it

Glue/Staple



rainy

Name _____

again?

By Lavinia Pop © 2015



stormy

Glue/Staple

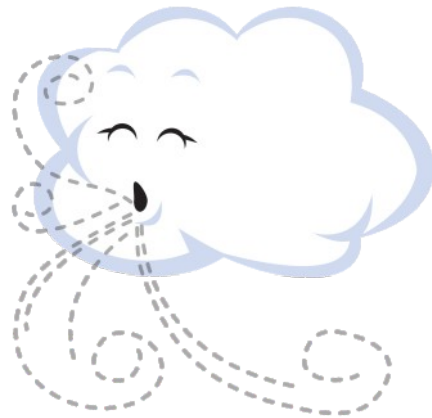

windy

Glue/Staple



snowy

Glue/Staple

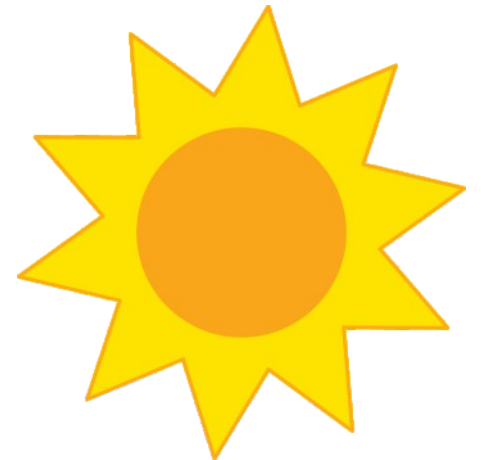

sunny

Name _____

Glue/Staple

I see an



otter.

By Lavinia Pop © 2015

Glue/Staple

Glue/Staple

Glue/Staple



ostrich.

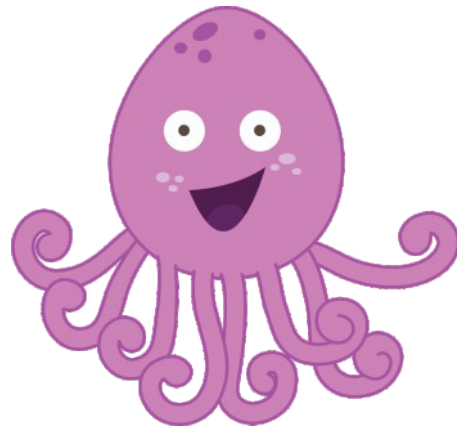

octopus.

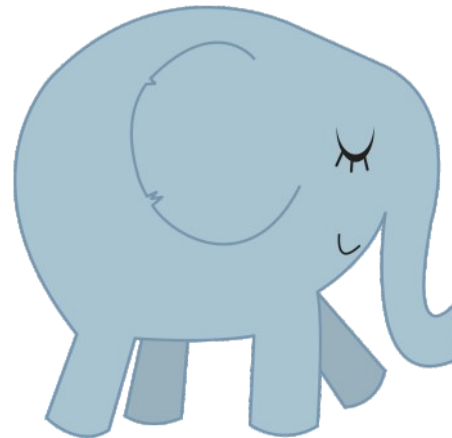

elephant.



eel.

Name _____

Do you have **any**

By Lavinia Pop © 2015

Glue/Staple

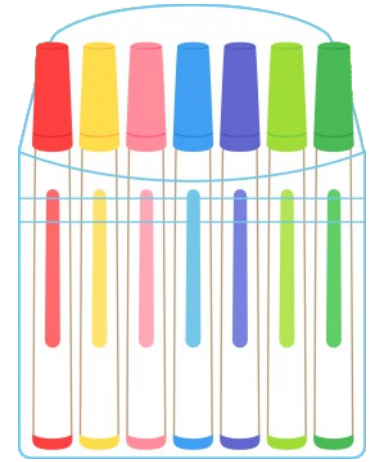

markers?



pencils?

Glue/Staple



glue?

Glue/Staple



crayons?

Glue/Staple

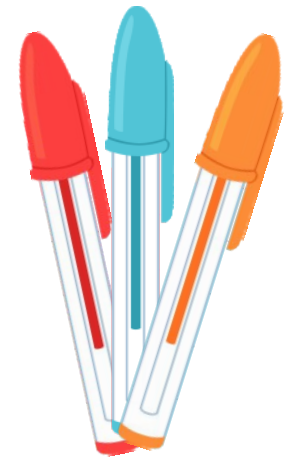

pens?

Name _____

Glue/Staple

I am **as** slow **as** a



snail.

By Lavinia Pop © 2015

Glue/Staple

Glue/Staple

Glue/Staple



seahorse.

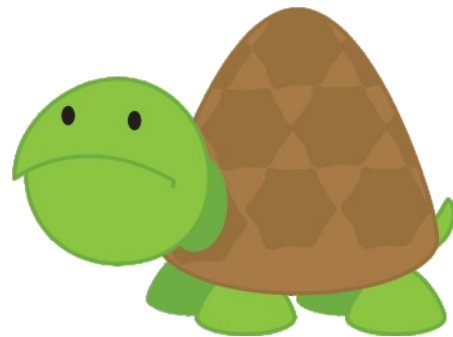

tortoise.

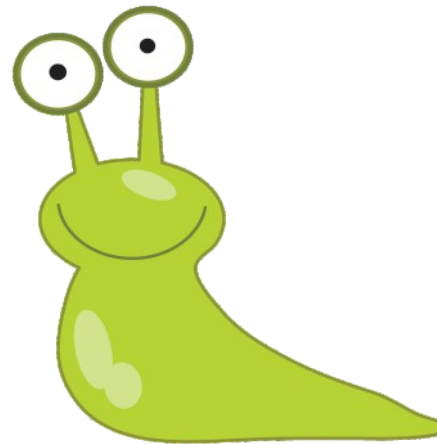

slug.



koala.

Name _____

Ask him to open the

By Lavinia Pop © 2015

Glue/Staple



drawers.



door.

Glue/Staple



jar.

Glue/Staple

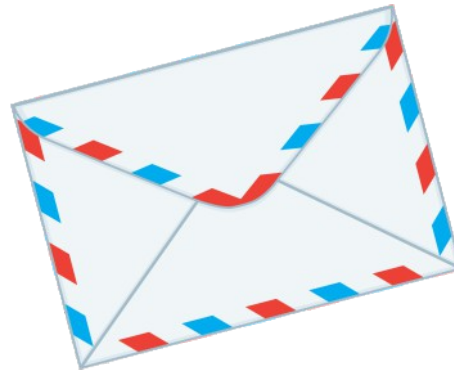

envelope.

Glue/Staple



window.

Name _____

Glue/Staple

We need to buy a



dresser.

By Lavinia Pop © 2015



chair.

Glue/Staple



bed.

Glue/Staple



table.

Glue/Staple

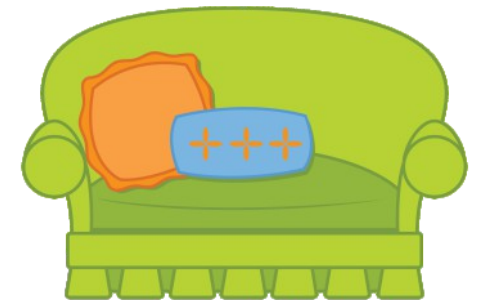

sofa.

Name _____

I could

By Lavinia Pop © 2015

Glue/Staple



hang.

Glue/Staple

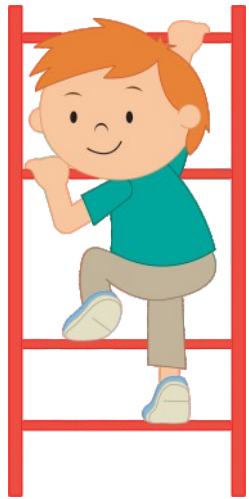

climb.

Glue/Staple



push.

Glue/Staple



swing.



pull.

She plays

Glue/Staple



tennis

Name _____

every day.

By Lavinia Pop © 2015

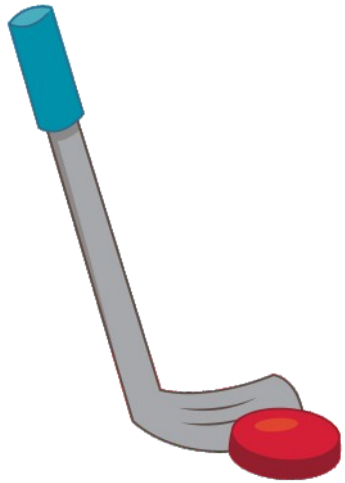

hockey

Glue/Staple



volleyball

Glue/Staple

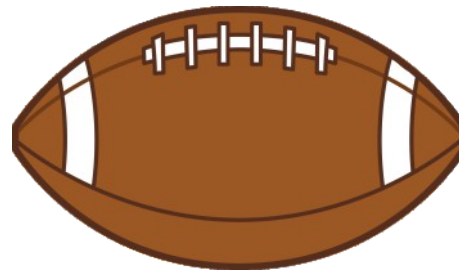

football

Glue/Staple



soccer

Name _____

Glue/Staple

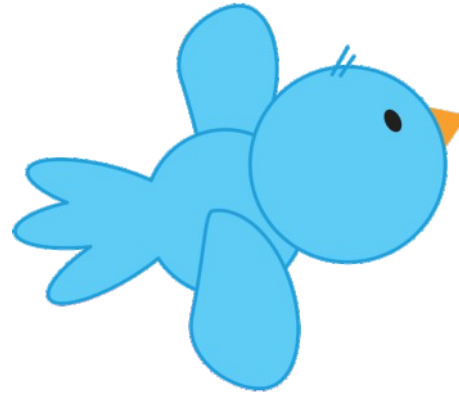

bird

fly!

Look at that

By Lavinia Pop © 2015

Glue/Staple

Glue/Staple

Glue/Staple



firefly



bee



bat



butterfly

The



ball

Name _____

is from me.

By Lavinia Pop © 2015



book

Glue/Staple



drum

Glue/Staple



bear

Glue/Staple

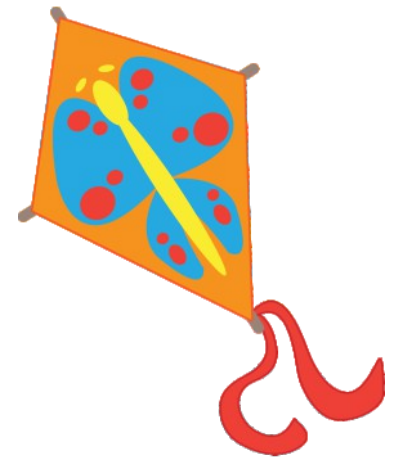

kite

Name _____

Glue/Staple

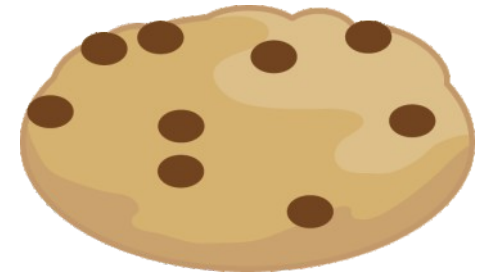

I will give him a

cookie.

By Lavinia Pop © 2015

Glue/Staple

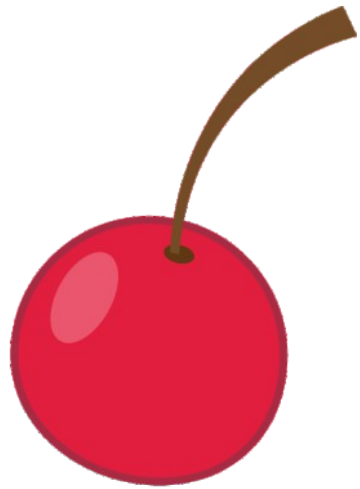

cherry.

Glue/Staple

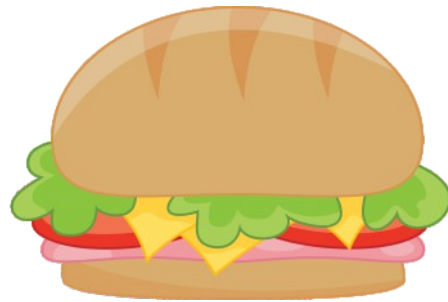

burger.

Glue/Staple



donut.



banana.

Name _____

Glue/Staple

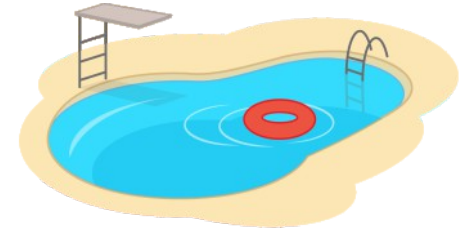

We are going to the

swimming
pool.

By Lavinia Pop © 2015

Glue/Staple



dentist.

Glue/Staple



police
station.

Glue/Staple



restaurant.



post
office.

Name _____

Glue/Staple

I had a blue



sweater.

By Lavinia Pop © 2015

Glue/Staple

Glue/Staple

Glue/Staple



ribbon.



pencil.

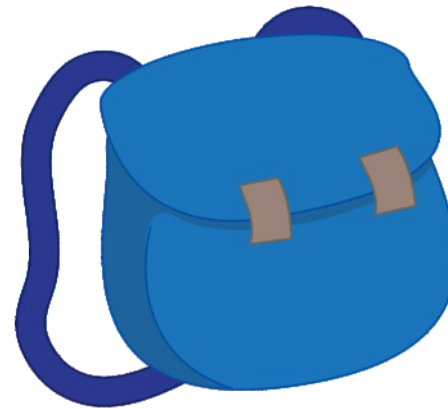

backpack.



drill.

Name _____

Glue/Staple



She **has** a green
desk.

By Lavinia Pop © 2015

Glue/Staple



frog.

Glue/Staple



top.

Glue/Staple

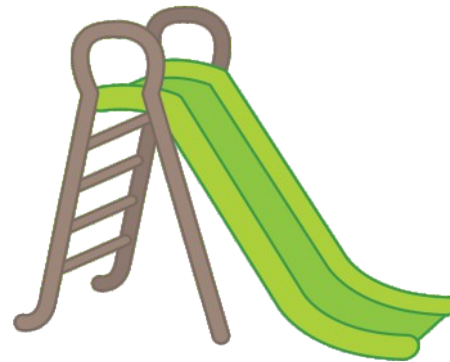

slide.

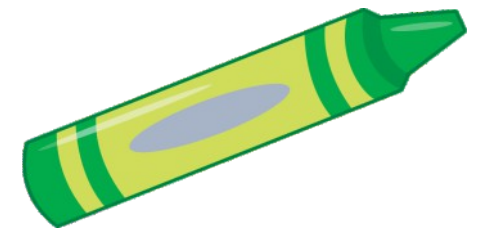

crayon.

Name _____

That is her

By Lavinia Pop © 2015

Glue/Staple



drum.

Glue/Staple

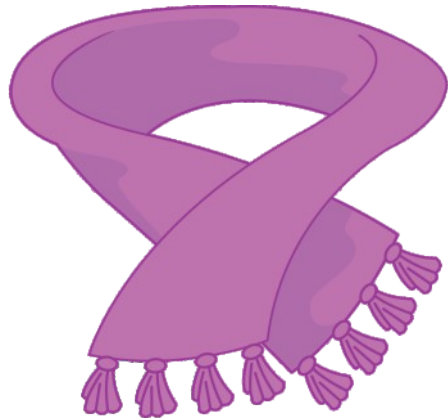

scarf.

Glue/Staple



skirt.

Glue/Staple



dog.

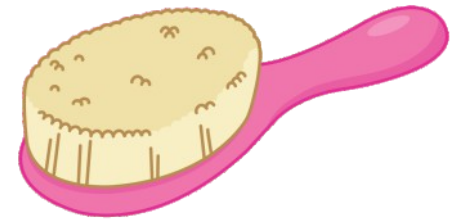

brush.

Name _____

Glue/Staple

Can you see **him**

By Lavinia Pop © 2015



ride?



swing?

Glue/Staple



run?

Glue/Staple



sweep?

Glue/Staple



juggle?

Name _____

Glue/Staple



compass.

That is his

By Lavinia Pop © 2015

Glue/Staple

Glue/Staple

Glue/Staple



vest.



shoe.



dog.



crown.

Name _____

How will I get
to the

By Lavinia Pop © 2015

Glue/Staple

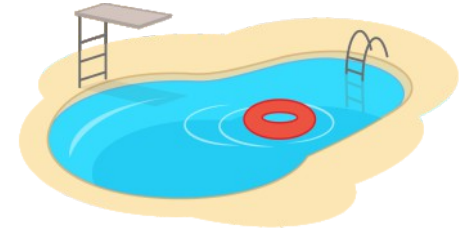

swimming
pool?



dentist?

Glue/Staple



police
station?

Glue/Staple



restaurant?

Glue/Staple



post
office?

Name _____

I **just** want
to see the

By Lavinia Pop © 2015

Glue/Staple



giraffe!

Glue/Staple



flamingo!

Glue/Staple



monkey!

Glue/Staple

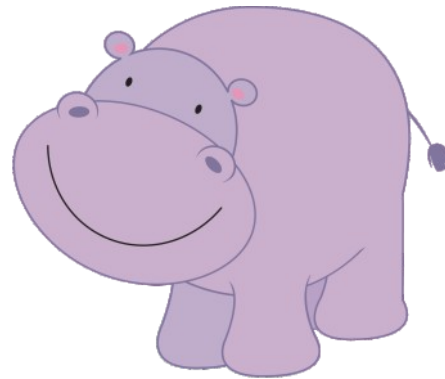

hippo!



tiger!

Name _____

Do you **know**
where the

Glue/Staple



bandage

is?

By Lavinia Pop © 2015



Glue/Staple



stethoscope thermometer

Glue/Staple



medicine

Glue/Staple

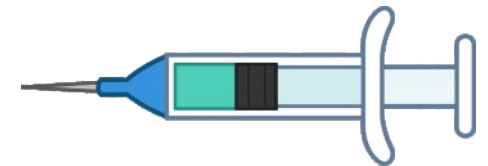

syringe

Name _____

Glue/Staple

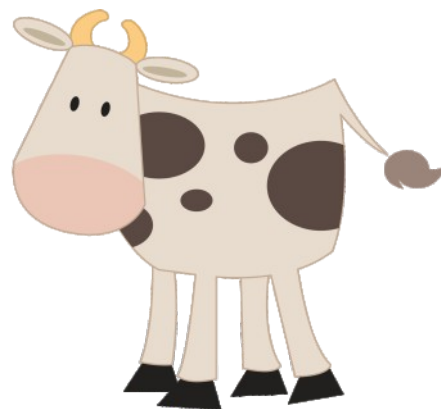

cow

Let the

come in.

By Lavinia Pop © 2015

Glue/Staple

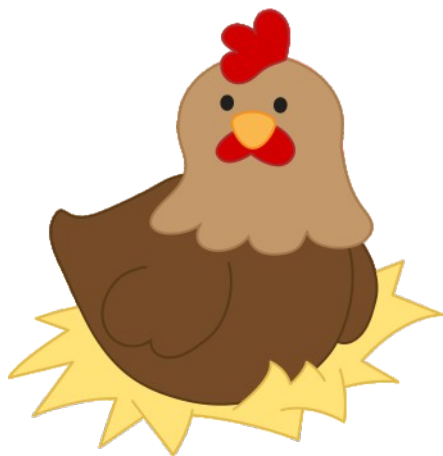

hen

Glue/Staple



pig

Glue/Staple

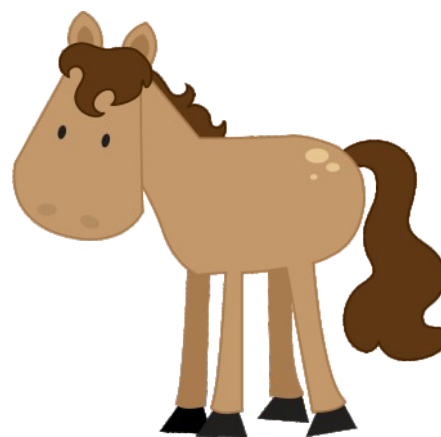

horse

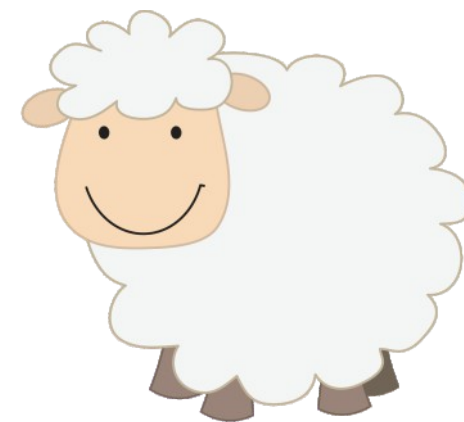

sheep

Glue/Staple

Name _____

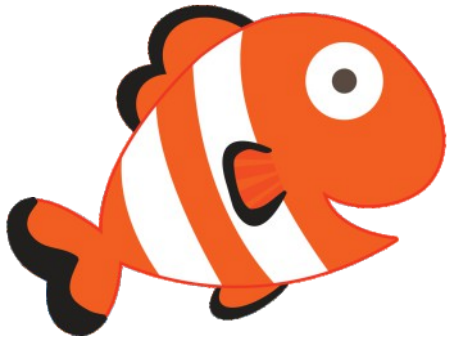

Fish

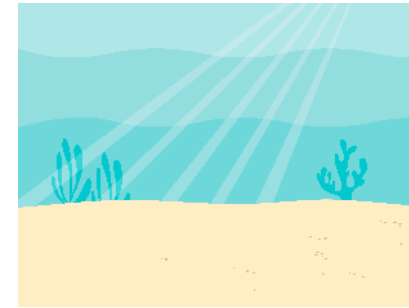

live in the ocean.

By Lavinia Pop © 2015

Glue/Staple



Seahorses

Glue/Staple

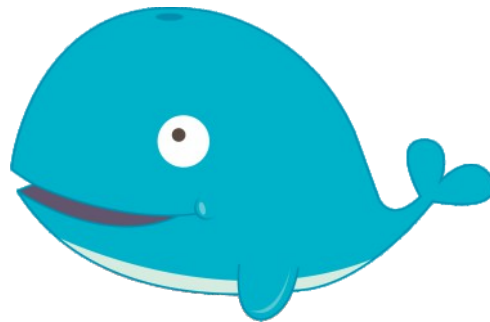

Whales

Glue/Staple



Crabs

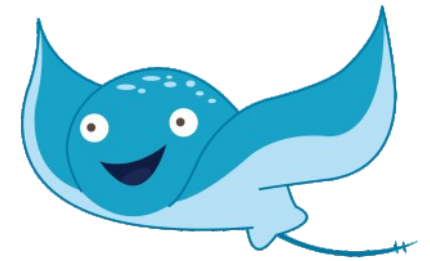

Stingrays

Name _____

I made a

Glue/Staple



cookie.

By Lavinia Pop © 2015

Glue/Staple

Glue/Staple

Glue/Staple



card.



gingerbread
man.



pinata.

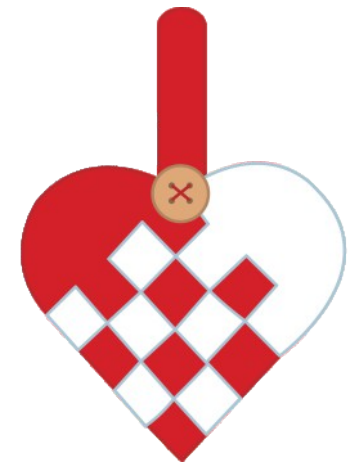

decoration.

Name _____

May I please
have some

By Lavinia Pop © 2015

Glue/Staple



pizza?

Glue/Staple



ice cream?

Glue/Staple



grapes?

Glue/Staple

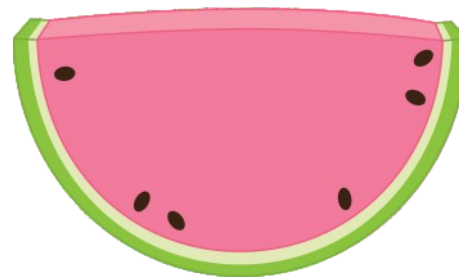

watermelon?



chocolate?

Name _____

Glue/Staple



I got out of the

van.

By Lavinia Pop © 2015

Glue/Staple

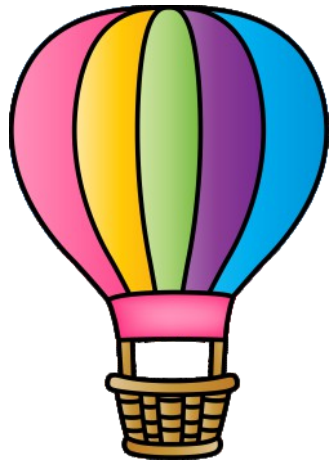

hot air
balloon.

Glue/Staple

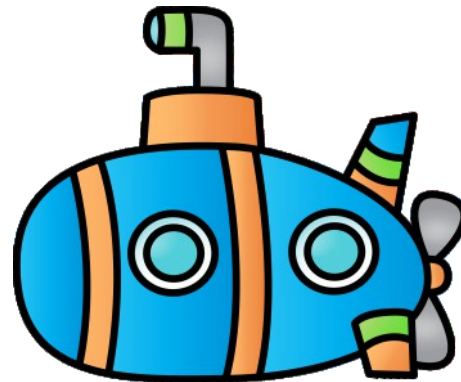

submarine.

Glue/Staple



car.



helicopter.

Name _____

Glue/Staple



How **old** is your

granddad?

By Lavinia Pop © 2015

Glue/Staple

Glue/Staple

Glue/Staple



mom?



dad?



sister?



brother?

Name _____

Glue/Staple



We **once** had a pet

hamster.

By Lavinia Pop © 2015

Glue/Staple

Glue/Staple

Glue/Staple



dog.

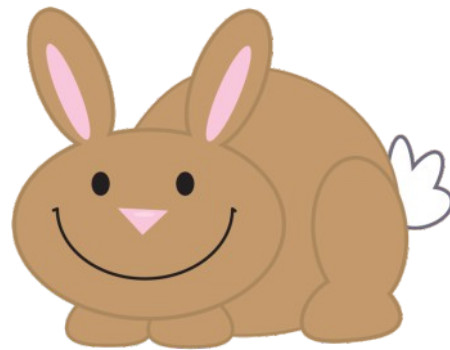

rabbit.



cat.

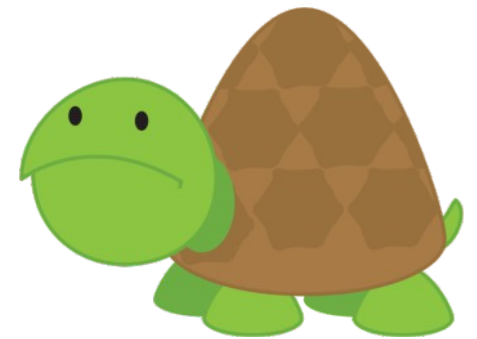

turtle.

Name _____

Please **open** the

By Lavinia Pop © 2015

Glue/Staple



drawers.

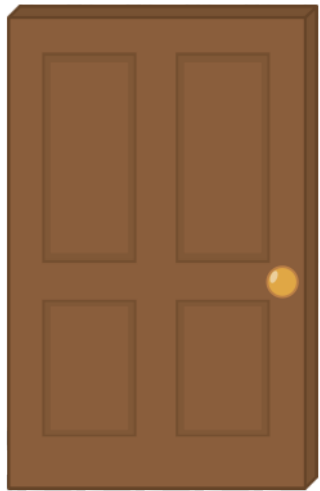

door.

Glue/Staple



jar.

Glue/Staple

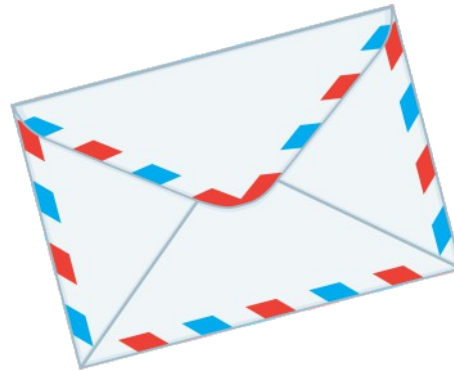

envelope.

Glue/Staple



window.

Name _____

He can jump
over the

By Lavinia Pop © 2015

Glue/Staple



bed.



chair.

Glue/Staple

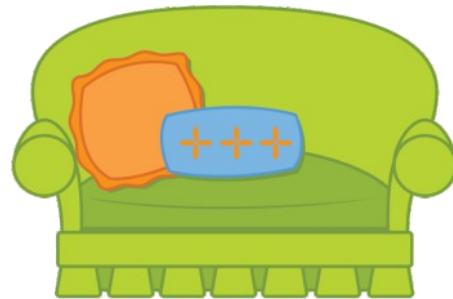

sofa.

Glue/Staple



table.

Glue/Staple



toy box.

Name _____

Glue/Staple

I put on my



sneakers.

By Lavinia Pop © 2015

Glue/Staple



socks.

Glue/Staple



shorts.

Glue/Staple



t-shirt.



cap.

Name _____

Glue/Staple

I have a round



coin.

By Lavinia Pop © 2015

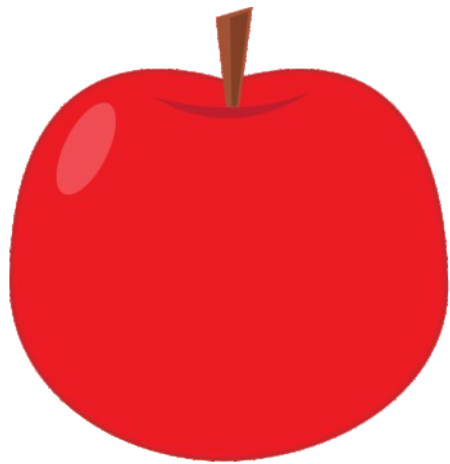

apple.

Glue/Staple



compass.

Glue/Staple

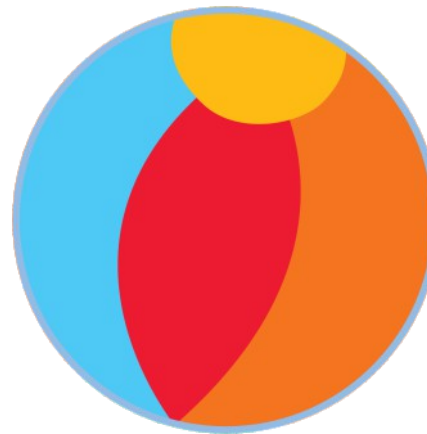

ball.

Glue/Staple



clock.

Name _____

There are **some**
apples in the

By Lavinia Pop © 2015

Glue/Staple



pie.

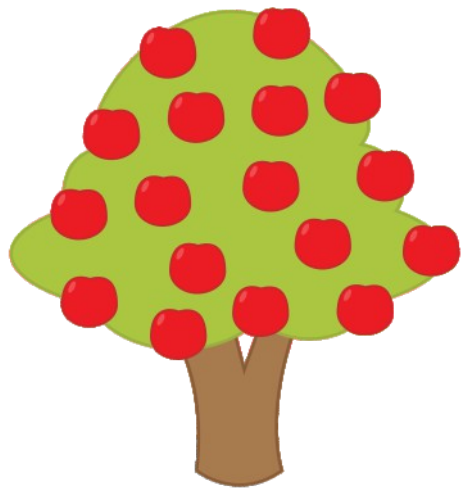

orchard.

Glue/Staple



basket.

Glue/Staple



crate.

Glue/Staple



juice.

Name _____

Glue/Staple



When will you **stop**

brushing?

By Lavinia Pop © 2015

Glue/Staple

Glue/Staple

Glue/Staple



wiggling?



dancing?



digging?



clapping?

Name _____

Glue/Staple

Did you **take** my



pencil?

By Lavinia Pop © 2015

Glue/Staple

Glue/Staple

Glue/Staple



backpack?



eraser?

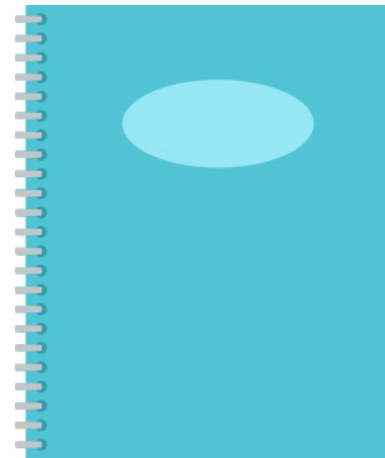

notebook?

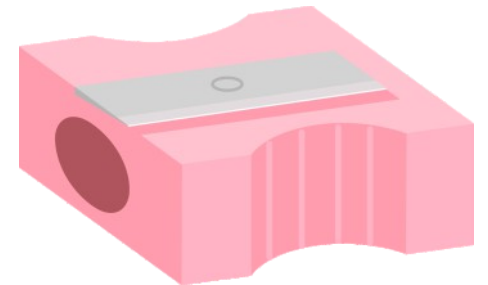

sharpener?

Name _____

Glue/Staple

Thank you for the



present.

By Lavinia Pop © 2015

Glue/Staple



flowers.

Glue/Staple



card.

Glue/Staple



apples.



cookie.

Name _____

Glue/Staple

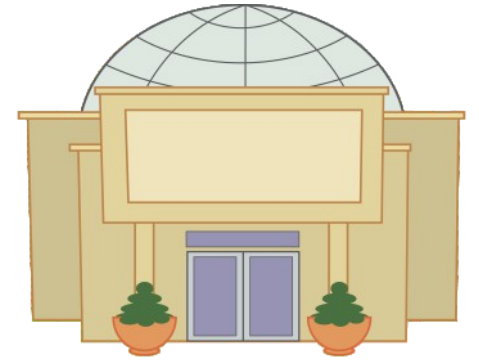

I saw **them** at the

museum.

By Lavinia Pop © 2015



post
office.

Glue/Staple



park.

Glue/Staple



store.

Glue/Staple



zoo.

Name _____

I will go home,
then I will

By Lavinia Pop © 2015

Glue/Staple



sleep.



eat.

Glue/Staple



play.

Glue/Staple



read.

Glue/Staple



draw.

Name _____

What do you
think is in the

By Lavinia Pop © 2015

Glue/Staple



mug?



bag?

Glue/Staple



chest?

Glue/Staple



box?

Glue/Staple

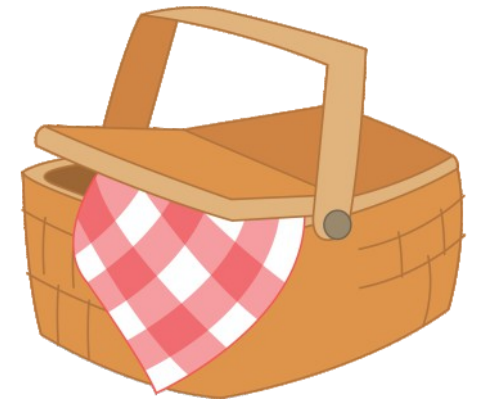

basket?

Glue/Staple

Name _____

Is the

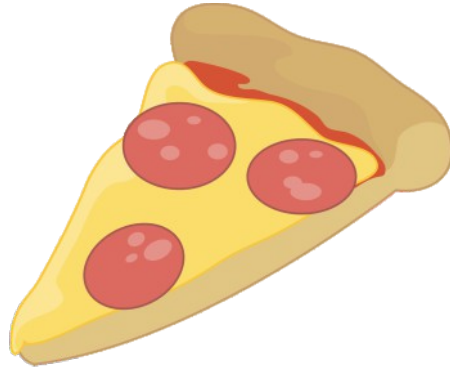

pizza

for **us**?

By Lavinia Pop © 2015

Glue/Staple

Glue/Staple

Glue/Staple



ice cream



yogurt

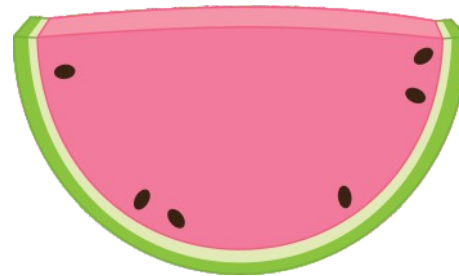

watermelon



chocolate

Name _____

Glue/Staple



I will **walk** my pet

hamster.

By Lavinia Pop © 2015

Glue/Staple

Glue/Staple

Glue/Staple



dog.

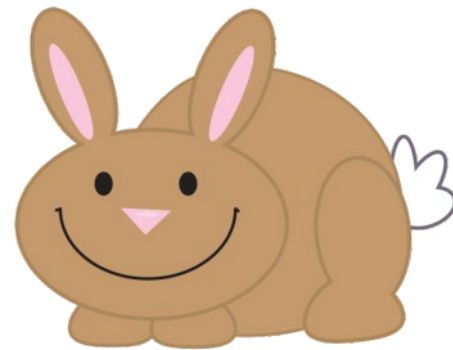

rabbit.



cat.

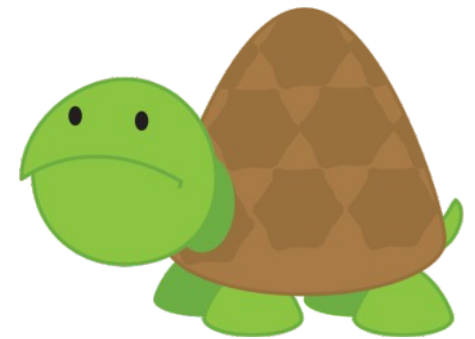

turtle.

Name _____

Were you playing

By Lavinia Pop © 2015

Glue/Staple



tennis?

Glue/Staple

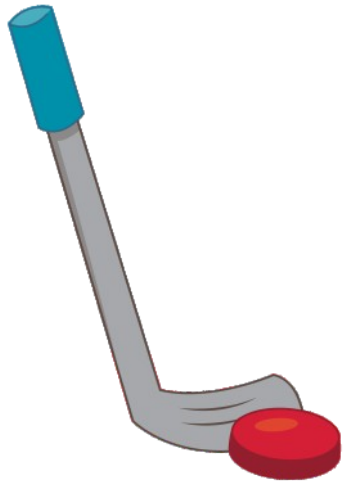

hockey?

Glue/Staple



volleyball?

Glue/Staple



football?

Glue/Staple



soccer?

Name _____

When did they
go to the

By Lavinia Pop © 2015

Glue/Staple



museum?

Glue/Staple

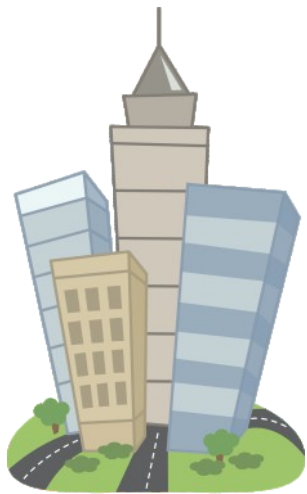

city?

Glue/Staple



park?

Glue/Staple



store?



zoo?

Name _____

Glue/Staple

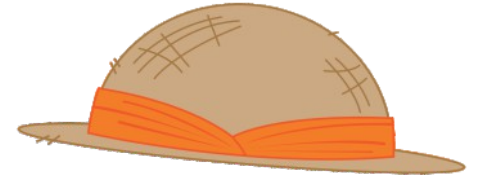

Where is **your**

hat?

By Lavinia Pop © 2015

Glue/Staple

Glue/Staple

Glue/Staple

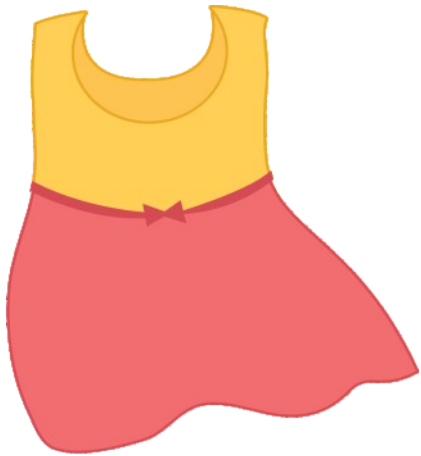

dress?



sweater?



coat?



shirt?